

Chapter 9

Sediment Control Practices

NELSON TASMAN
**EROSION AND SEDIMENT
CONTROL GUIDELINES**

JULY 2019



TABLE OF CONTENTS

9	SEDIMENT CONTROL PRACTICES	1
9.1	Sediment Retention Ponds	2
9.1.1	Definition and purpose.....	2
9.1.2	Conditions where practice applies.....	2
9.1.3	Limitations.....	2
9.1.4	Key design criteria	3
9.1.5	Construction specifications.....	16
9.1.6	Maintenance	16
9.1.7	Decommissioning	17
9.2	Silt Fences	18
9.2.1	Definition and purpose.....	18
9.2.2	Conditions where practice applies.....	18
9.2.3	Limitations.....	18
9.2.4	Key design criteria	19
9.2.5	Construction.....	23
9.2.6	Maintenance	23
9.2.7	Decommissioning	23
9.3	Super Silt Fence	24
9.3.1	Definition and purpose.....	24
9.3.2	Conditions where practice applies.....	24
9.3.3	Limitations.....	24
9.3.4	Key design criteria	25
9.3.5	Construction.....	27
9.3.6	Maintenance	28
9.3.7	Decommissioning	28
9.4	Decanting Earth Bund	29
9.4.1	Definition and purpose.....	29
9.4.2	Conditions where practice applies.....	29
9.4.3	Limitations.....	29
9.4.4	Key design criteria	29
9.4.5	Construction.....	30
9.4.6	Maintenance	31
9.4.7	Decommissioning	31
9.5	Flocculation	33
9.5.1	Definition and purpose.....	33
9.5.2	Conditions where the practice applies.....	33
9.5.3	Limitations.....	34
9.5.4	Key design criteria	34
9.5.5	Decommissioning	36
9.6	Dewatering.....	37
9.6.1	Definition and purpose.....	37
9.6.2	Conditions where practice applies.....	37
9.6.3	Limitations.....	37
9.6.4	Key design criteria	37
9.6.5	Maintenance and Decommissioning	38

9.7	Sediment Sump	38
9.7.1	Definition and Purpose	38
9.7.2	Conditions where practice applies.....	38
9.7.3	Limitations.....	38
9.7.4	Key Design and Construction Criteria	38
9.7.5	Maintenance	39
9.7.6	Decommissioning	39
9.8	Stormwater Inlet Protection	41
9.8.1	Definition and purpose.....	41
9.8.2	Conditions where practice applies.....	41
9.8.3	Limitations.....	41
9.8.4	Key design and construction criteria	42
9.8.5	Maintenance	43
9.8.6	Decommissioning	44

LIST OF TABLES

Table 9-1	Silt fence design criteria	19
Table 9-2	Super silt fence design criteria	25

LIST OF FIGURES

Figure 9-1	Sediment Retention Ponds (forebay in foreground of upper photo, decants in lower photo)	2
Figure 9-2	Schematic of a Sediment Retention Pond (Auckland Councils')	4
Figure 9-3	Level Spreader and Forebay.....	7
Figure 9-4	Level Spreader	8
Figure 9-5	Sediment retention pond detail showing multiple decants	9
Figure 9-6	Sediment Retention Pond – Decant Detail (Auckland Councils').....	10
Figure 9-7	Sediment Retention Pond T-bar decant system for Catchments less than 1.5 ha	11
Figure 9-8	Sediment Retention Pond T-bar decant system for Catchments Between 1.5 – 3 ha.....	12
Figure 9-9	Sediment Retention Pond T-bar decant system for Catchments Between 3 – 5 ha.....	13
Figure 9-10	Filter Collar Schematic Detail	15
Figure 9-11	Construction of a Sediment Retention Pond	16
Figure 9-12	Silt fence with returns to reduce lateral water movement	18
Figure 9-13	Schematic of a Silt Fence.....	20
Figure 9-14	Super Silt Fence	24
Figure 9-15	Schematic of a Super Silt Fence	26
Figure 9-16	Decanting Earth Bund	29
Figure 9-17	Decanting Earth Bund with a Floating Decant	30
Figure 9-18	Floating Decant in DEB	30
Figure 9-19	Cross-section Decanting earth bund.....	31
Figure 9-20	Rain Activated Flocculant Dosing System (Auckland Council)	33
Figure 9-21	Modified Skip Bin for Dewatering	37
Figure 9-22	Dewatering Pipe Sock and Bag.....	38
Figure 9-23	Sediment Sump (source ARC TP90 1999)	40
Figure 9-24	Stormwater Inlet Protection – silt fence and geotextile sock.....	41
Figure 9-25	Inlet protection with aggregate on top of geotextile fabric.....	42
Figure 9-26	Stormwater Inlet Protection Filter Media Design.....	43
Figure 9-27	Sandbag check dam in gutter.....	43

9 SEDIMENT CONTROL PRACTICES

The sediment controls outlined in this section are:

- Sediment Retention Ponds
- Decanting Earth Bunds
- Super silt Fences
- Silt Fences
- Flocculation
- Dewatering
- Sediment sumps
- Storm inlet protection.

The success of sediment control devices is not solely dependent on their capacity, but also other important design features, correct construction and regular maintenance and monitoring to ensure optimum treatment efficiencies.

Soil particle size and catchment size, characteristics and hydrology are critical factors that can influence device sizing and their location. These factors are extremely variable and need to be taken into account on a site-by-site basis when developing an ESCP for your project.

The process for device selection and sizing should include the following aspects (refer also Appendix 13.7):

- A risk analysis to determine:
 - the potential for erosion and expected sediment yields
 - the size, land cover and soil types of contributing catchments
 - the sediment transport pathways on and off the site
 - the types and sensitivity of receiving environments
- A soils analysis (including a soil particle analysis if sediment retention ponds are considered).
- Determination of works methodologies including staging and sequencing.
- Sizing of storage requirements as per Appendix 13.7.
- Determination if flocculation is required.

For sites on Moutere Gravels it is likely that flocculation will be required to adequately control fine sediments. Refer section 9.5 for further information on flocculation.

9.1 Sediment Retention Ponds

9.1.1 Definition and purpose

A sediment retention pond (SRP) is a temporary pond formed by excavation into natural ground or by the construction of an embankment and incorporating a device to dewater the pond at a rate that will allow the majority of suspended sediment to settle out.

The purpose of a sediment retention pond is to provide a low velocity environment where suspended sediments can settle and also to provide some detention of water runoff. This reduces the volume of sediment leaving a site and helps protect downstream environments from excessive sedimentation, water quality degradation and impacts of increased flow on stream channels.

9.1.2 Conditions where practice applies

Sediment retention ponds are appropriate where treatment of sediment laden runoff is necessary and are generally considered the appropriate control measure for exposed catchments of more than 0.3 ha.

It is vital that the sediment retention pond is maintained until the disturbed area is fully protected against erosion by permanent stabilisation (refer section 9.3).

9.1.3 Limitations

Sediment retention ponds have the following limitations:

- Sediment retention ponds can occupy significant space (footprint and associated side slopes). This needs to be recognised when designing an ESCP.
- Embankment and spillway stability are generally the weak points in sediment retention pond construction. Correct compaction particularly around emergency spillways and discharge pipes and the use of antiseep or filter collars, will keep the system robust. In a number of cases (e.g. steep slopes and low strength soils) specific geotechnical design will be required.
- Decant systems can become blocked resulting in overtopping and poorly treated runoff discharging to the receiving environment. Pulley systems attached to decants can assist, however maintenance is paramount to ensure that overtopping and sediment discharge does not occur.
- The pond features need to be carefully monitored and reviewed once constructed to ensure the pond operates as designed.
- Sediment retention ponds are often not effective in areas with fine grained soils such as on Moutere Gravels. The presence of suspended fine clays will require the use of flocculants. In these areas it is necessary to ensure that erosion control practices are a key focus to reduce sediment loads and adequately protect the receiving environment.



Figure 9-1 Sediment Retention Ponds (forebay in foreground of upper photo, decants in lower photo)

9.1.4 Key design criteria

The sediment retention pond design is such that very large runoff events will receive at least partial treatment and smaller runoff events will receive a high level of treatment. To achieve this, the energy of the inlet water needs to be low to minimise re-suspension of sediment and the decant rate of the outlet also needs to be low to minimise water flow-through rates and to allow sufficient detention time for the suspended sediment to settle out (Refer Figure 9-2).

Specific design criteria are discussed in the sections below including:

- Pond location.
- Pond volume.
- Pond shape and depth.
- Specific pond features (embankments, baffles, forebay, level spreader, decants and outlet and primary and emergency spillways).

General design criteria can be summarised as the following:

- Use sediment retention ponds for bare areas of 0.3 ha or greater.
- Restrict catchment areas to less than 5ha per sediment retention pond. This limits the length of overland flow paths and reduces maintenance problems. If larger catchments are to be treated specific design and detail will need to be provided.
- Locate sediment retention ponds to provide a convenient collection point for sediment laden flows from the catchment area. This will require strategic use of cut-offs, runoff diversion channels and contour drains.
- Provide maintenance access to allow for removing sediment from the pond.
- Wherever possible, locate sediment retention ponds to allow the primary outlet and spillway to discharge over undisturbed, well vegetated ground.
- Keep the sediment retention ponds life to less than two years. If a longer term is required then further measures to ensure stability and effectiveness are likely to be needed.
- **Never** locate sediment retention ponds within watercourses or flood flow paths.

9.1.4.1 Safety

Sediment retention ponds are attractive to children and can become safety hazards if not appropriately fenced and if safety rules are not followed. Low gradient pond batters provide an additional safety measure allowing people to easily get out if they fall in. Department of Labour guidelines for general safety in the construction industry also recommend that “*excavations are fenced, and, if they are like to retain water, are covered and securely fenced to prevent access for children. If in public places, they should have warning signs, and warning lights at night.*” (DoL 1995).

9.1.4.2 Requirement for flocculation

If any of the following may occur, flocculation should also be used in ponds to provide better retention of fine sediments:

- If pond sizes calculated using the design method in Appendix 13.5 cannot be met on site due to land availability, site topography or works layout.
- If the preferred pond shape and ratios cannot be met on site due to land availability, site topography or works layout.

- If contributing catchment soils have particularly high levels of clays, such as areas within Moutere Gravels.
- If the pond, once operational, is allowing the discharge of excessively dirty water that mean discharges are unlikely to meet the TRMP and NRMP discharge standards.
- If receiving environment is particularly sensitive to sediment discharges and a high level of treatment is required.

When designing a flocculant-dosed sedimentation pond the following features should be included:

- Turbulence can be helpful at the dosing point to aid in mixing.
- Provision of a suitable flat area to locate a flocculant dosing shed and all-weather vehicle access to the shed for monitoring and maintenance.

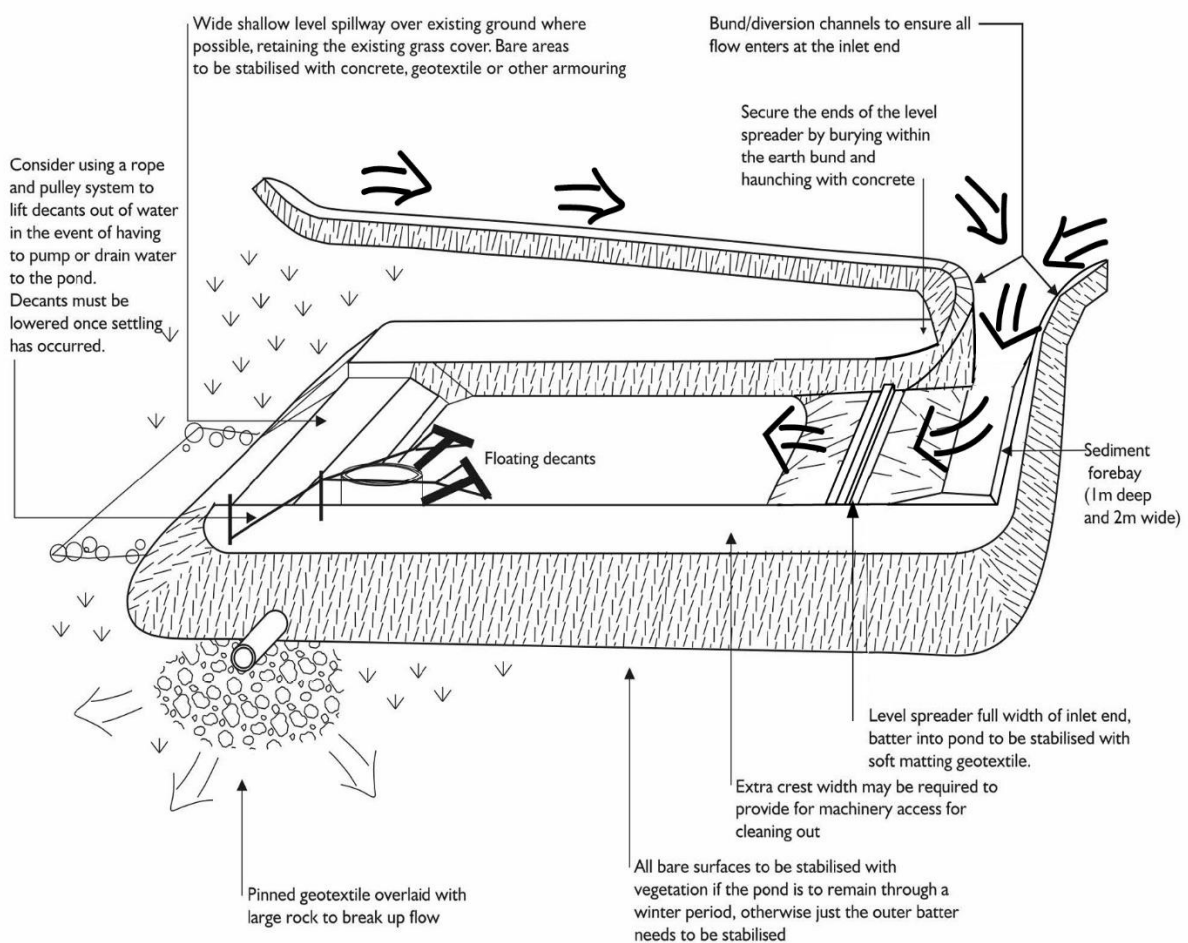

Figure 9-2 Schematic of a Sediment Retention Pond (Auckland Councils')

9.1.4.3 Location of the pond

The location of the sediment retention pond needs to be carefully considered in terms of the overall project. Initial considerations include:

- The available room for construction and maintenance of the pond.

- The final location of any permanent stormwater retention facilities that may be constructed at a later stage. In this respect, there may be opportunity to excavate a sediment retention pond for use during the earthworks stage in the same location, which can then be modified to form the permanent stormwater feature once works are fully stabilised.
- Whether drainage works can be routed to the sediment retention pond until such time as the site is fully stabilised. This eliminates the need to install and maintain stormwater inlet protection or other sediment controls throughout the latter stages of a development.

Consideration should also be given to where the sediment collected in the pond will be disposed of - over a reasonable time period this could be tonnes of material.

9.1.4.4 Pond Volume

The general design approach is to create an impoundment of sufficient volume to capture a significant proportion of the design runoff event, and to provide still water conditions which promote the settling of suspended sediment.

There are two issues to consider in sizing ponds:

1. **Storage volume** for sediment control –the design methodology is outlined in Appendix 13.5, and
2. **Discharge rate** - to ensure that downstream stream channel erosion is not increased during construction – a standardised methodology for this is outlined in 9.1.4.10, but if required can also be calculated using the detailed design method in Appendix 13.5.

When calculating the volume of the sediment retention pond use the depth measured from the base of the sediment retention pond to the top of the primary spillway. This incorporates both the live storage and dead storage volumes (refer Figure 9-7). There should be a 300mm freeboard between the primary spillway and the emergency spillway.

Clearly show the sediment retention pond dimensions necessary to obtain the required pond volume on the site's Erosion and Sediment Control Plan (refer Chapter 6).

9.1.4.4.1 Dead storage (permanent storage)

- Dead storage is the component of pond volume that does not decant and remains in the sediment retention pond. It is important for dissipating the energy of sediment laden inflows and to reduce resuspension potential.
- Ensure dead storage is 30% of the total sediment retention pond volume by positioning the lowest decant at the design height above the invert of the sediment retention pond.
- The approved decant design detailed in this guideline allows the lower decant arm to be raised as sediment deposition increases, thereby maintaining the percentage volume of dead storage.

9.1.4.4.2 Live storage (decant storage)

- Live storage is the pond volume between the lowest decant outlet level and the crest of the primary spillway.
- Ensure that the live storage volume capacity is 70% of the total sediment retention pond volume.
- The decant design allows the decant system to be raised as sediment deposition increases, thereby maintaining the percentage volume of live storage.

9.1.4.4.3 Shape of the pond

- Ensure the length to width ratio of the sediment retention pond is no less than 3:1 and no greater than 5:1 measured at the midslope of the SRP. The length of the sediment retention pond is measured as the distance between the inlet and the outlet (ie decant system).
- Maximise the distance between the inlet and the outlets (including the emergency spillway) to reduce the risk of short circuiting and to promote still water conditions. If this cannot be achieved by correctly positioning the inlet and outlets, install baffles to achieve the appropriate length to width ratio design.
- Ensure that the sediment retention pond has a level invert to promote the even and gradual dissipation of the heavier inflow water across the full area of the sediment retention pond.
- Ensure the pond embankment width is sufficient for digger access to allow easy removal of accumulated sediment.

9.1.4.5 Depth of pond

- Sediment retention pond depths may be 1 – 2m deep, but no deeper than 2m. Deeper ponds are more likely to cause short circuiting problems during larger storm events, require specifically designed floating decant systems and could represent a safety hazard.
- The decant design in this guideline operates through a maximum live storage range of 1.5m.

9.1.4.6 Baffles

Baffles are used to increase the length that flows travel within the pond to allow for more time for sediments to settle out. They are also used to reduce the effect of wind in resuspension of accumulated sediments in large ponds.

- Incorporate baffles in the sediment retention pond design where the recommended pond shape cannot be achieved or where ponds are very large (eg greater than 400m³ per ha of contributing catchment).
- Extend baffles the full depth of the sediment retention pond and place them to maximise dissipation of flow energy.
- Generally, baffles are in the form of a wing to direct inflows away from the outlet and maximise the stilling zone and flow path. A series of compartments within the pond can be used to achieve this, although care should be taken to avoid creating in-pond currents and resuspension of light particulates.
- Baffles may be constructed from various materials ranging from solid shutter boards to braced geotextile curtains.

9.1.4.7 Embankment

Thoroughly compact the sediment retention pond embankment, with material laid in 150mm layers and compacted to standards set out in the Nelson Tasman Land Development Manual (NTLDM).

- In a number of instances (e.g. steep slopes and/or low strength soils) specific geotechnical design and certification will be required.
- Where possible install the discharge pipes through the embankment as the embankment is being constructed.
- Fully stabilise the external batter face, by vegetative or other means, immediately after construction.
- Ensure all bare areas associated with the sediment retention pond (including internal batters) are stabilised.

9.1.4.8 Forebay

- Construct a forebay with a volume equal to 10% of the design pond volume.
- The forebay should extend the full width of the pond and be a maximum of 1m in depth.
- The forebay is upstream of the level spreader.
- Access is to be maintained to the forebay at all times to allow removal of accumulated sediment.

9.1.4.9 Level spreader

Incorporate a level spreader into the inlet design to spread inflow, reduce velocities and maximise the full size of the pond.

- Ensure the level spreader is level, non-erodible and spans the full width of the sediment retention pond
- A level spreader can consist of a 150mm x 50mm straight timber plank (or equivalent) laid on its edge, levelled and fastened into place with concrete, bolted through waratah or other fasteners. Timber stakes are not recommended as they usually move.



Figure 9-3 Level Spreader and Forebay

- Position the top of the level spreader 100 – 200mm above the invert of the emergency spillway. Concrete haunching should be placed at both sides of the level spreader to ensure no outflanking or undercutting.
- Combine the level spreader with a well compacted and smoothed inlet batter (no steeper than a 3:1 gradient). Lay geotextile fabric in the level spreader trench and down the inlet batter to the dead storage level. To ensure flows do not outflank the level spreader use concrete haunching at the ends.

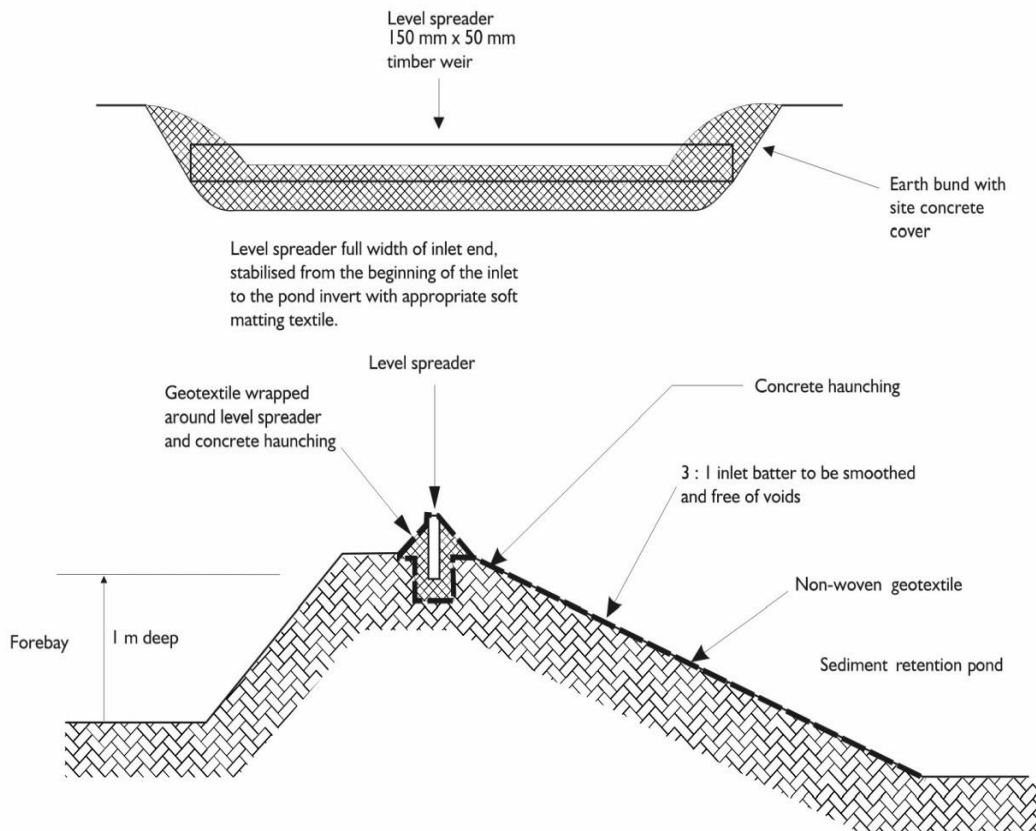

Figure 9-4 Level Spreader

9.1.4.10 Dewatering devices (T-Bar Decant)

The dewatering device aims to remove the water within the upper water column –where the water is cleanest- without removing any of the settled sediment, and without removing any appreciable quantities of floating debris.

Various dewatering devices are available, however the use of a floating T-bar dewatering device is necessary in the Tasman region. This allows for the decanting of the cleaner water from the top of the water column. Substantiated performance design will need to be required for decant systems other than the floating T-bar dewatering device.

For simplicity, this guide recommends a standard T-bar decant that provides a decant rate of 4.5 litres per second per decant (refer Figure 9-6). Additional standardised decants can be added to accommodate various sized catchments (1 standardised decant per 1.5ha contributing catchment).

To create a standardised, decant that achieves a decant rate of 4.5 litres per second per decant, drill 6 rows of 10mm diameter holes at 60mm spacings (200 holes) along a 2m long decant arm.

If required, the detailed design methodology in Appendix 13.7 can be utilised to determine site-specific decant designs for any contributing catchment area.

- Single T-bar decants should be able to operate through the full live storage depth of the sediment retention pond.
- The decant design in this guideline operates through a maximum live storage range of 1.5m. For catchments of less than 1.5ha, seal off the appropriate number of holes to achieve a 3 litres/second/hectare discharge rate see Figure 9-7.
- If two decant systems are required (refer figure 9-8), ensure the lower T-bar decant operates through the full live storage depth of the sediment retention pond. The upper T-bar decant is to operate through the upper 50% of the live storage depth only.



Figure 9-5 Sediment retention pond detail showing multiple decants

- If three decant systems are to be used (Figure 9-8), then the lower T-bar decant operates through the full live storage depth and the second T-bar decant through the upper two thirds of live storage depth of the sediment retention pond. The upper T-bar decant operates through the upper one third of live storage depth of the sediment retention pond.
- Ensure that the T-bar decant float is securely fastened with steel strapping directly on top of the decant arm and weight it to keep the decant arm submerged just below the surface through all stages of the decant cycle. This will also minimise the potential for blockage of the decant holes by floating debris. The most successful method found to date is to weight the decant arm by strapping a 1.8m long waratah between the float and the decant (approximately 4kg of weight).
- Position the T-bar decant at the correct height by tying 5mm nylon cord through decant holes at either end of the decant arm and fastening it to waratahs driven in on either side of the decant.
- Use a flexible, thick rubber coupling to provide a connection between the decant arm and the primary spillway or discharge pipe. To provide sufficient flexibility for lower decant arms install two couplings. Fasten the flexible coupling using strap clamps, glue and screws.
- Where a concrete riser decant system is utilised, ensure the lower decant connection is positioned on an angle upwards from the horizontal so as to split the operational angle that the decant works through. This will reduce the deformation force on the coupling used.
- Rope and pulley systems installed on the decants allow for easy maintenance of discharge holes and also allows for discharge from ponds to be temporary stopped if needed (for example to prevent water pollution while cleaning up non-sediment spills that enter pond).

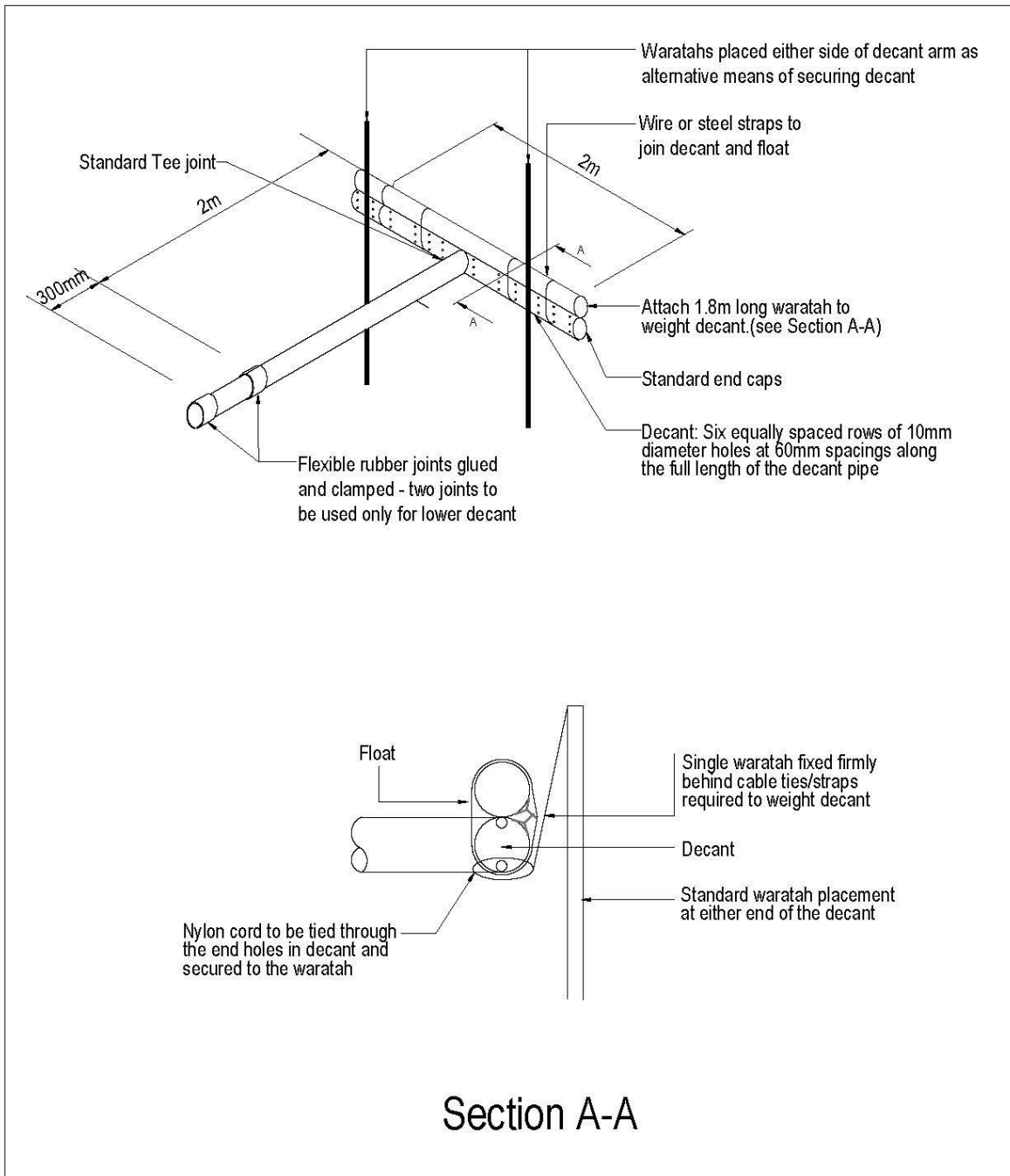

Figure 9-6 Sediment Retention Pond – Decant Detail (Auckland Councils')

Schematics of decant systems in sediment retention ponds for catchment areas of less than 1.5ha, 1.5 to 3ha and 3ha to 5ha are shown in the following figures.

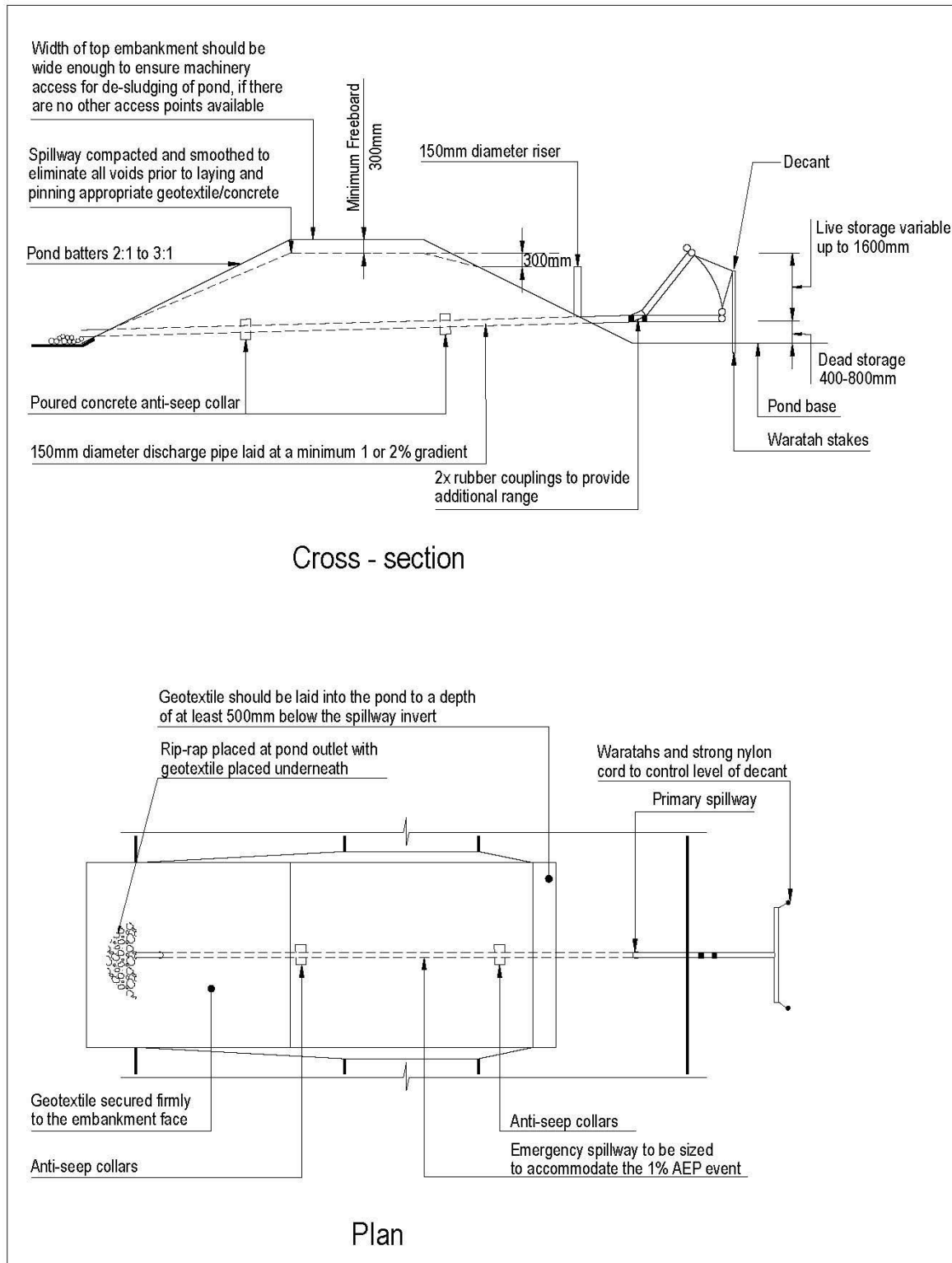

Figure 9-7 Sediment Retention Pond T-bar decant system for Catchments less than 1.5 ha

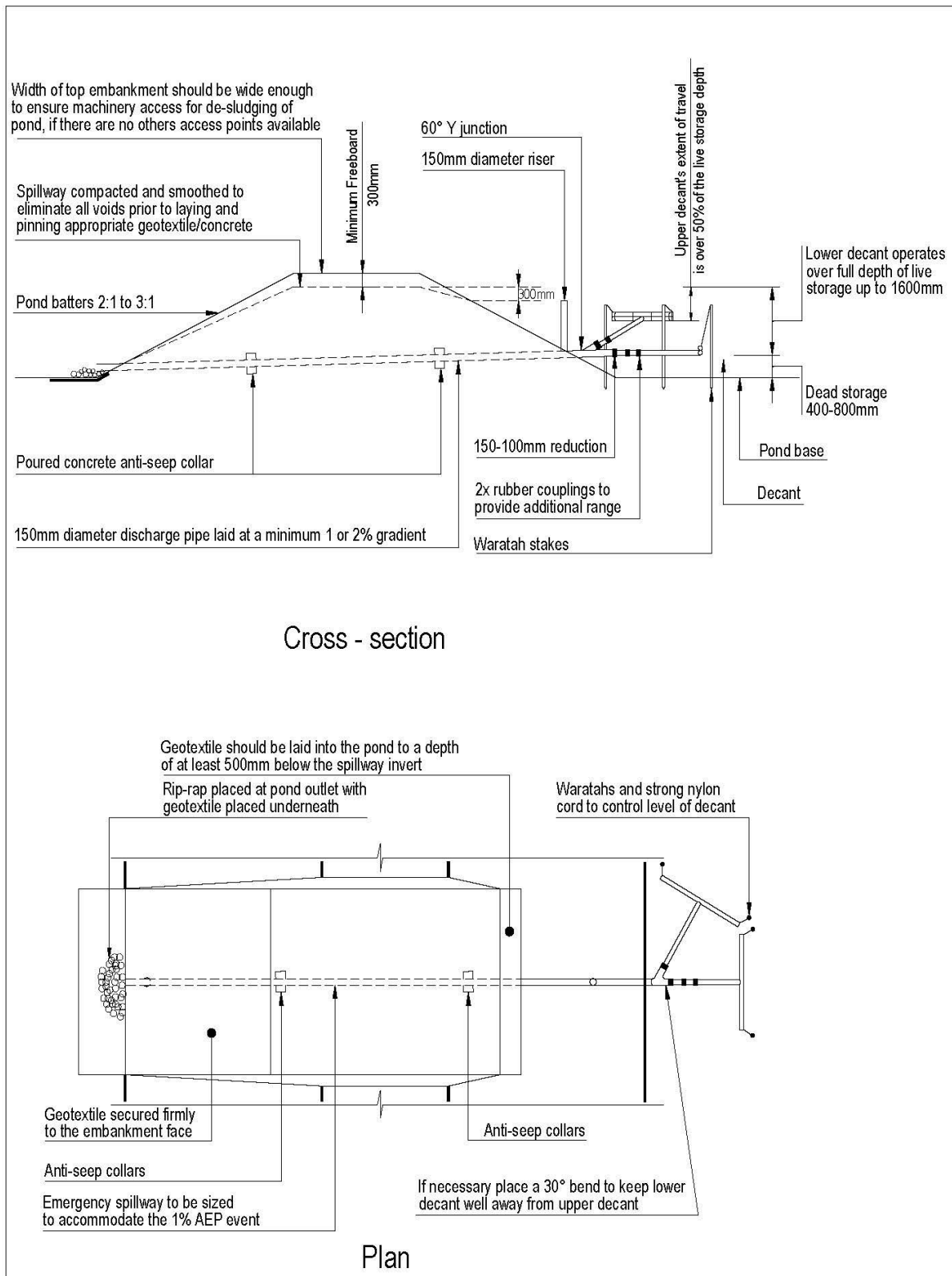

Figure 9-8 Sediment Retention Pond T-bar decant system for Catchments between 1.5 – 3 ha

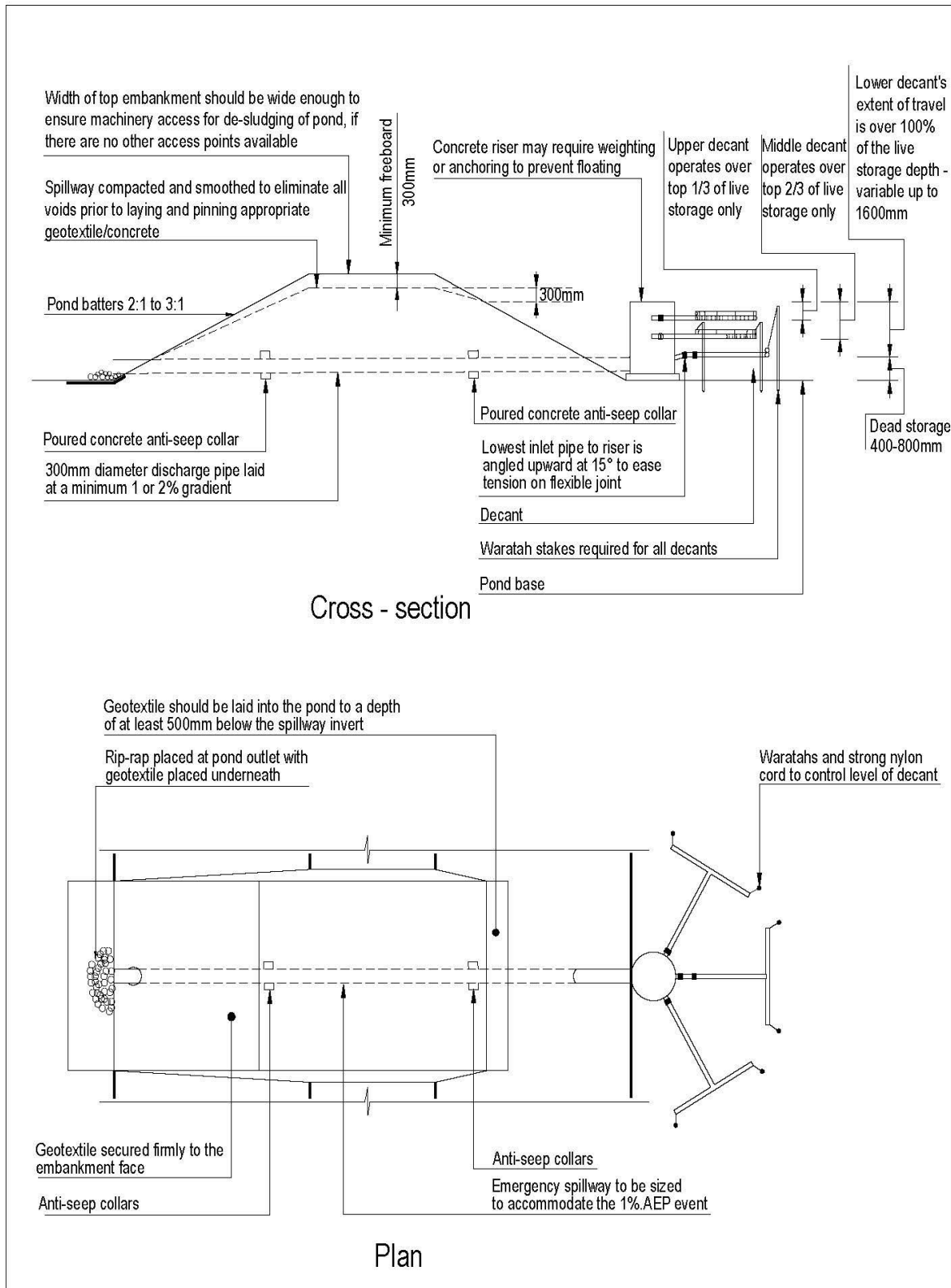

Figure 9-9 Sediment Retention Pond T-bar decant system for Catchments Between 3 – 5 ha

9.1.4.11 Primary spillway

For catchments up to 1.5ha, decant flows can be piped using the same diameter piping as the decant system (100mm PVC smooth bore) directly through the sediment retention pond wall to discharge beyond the toe of the sediment retention pond wall.

For catchments larger than 1.5ha the sediment retention pond requires a piped primary spillway (refer Figure 9-8 and Figure 9-9).

- For contributing catchments between 1.5 and 3ha in area, use a discharge and primary spillway pipe diameter of 150mm.
- Where contributing catchments are 3ha or greater and/or the long term stability of the sediment retention pond emergency spillway is questionable (for example, built in fill) incorporate a concrete manhole riser and larger diameter pipe outlet as a primary spillway sufficient to accommodate the 5% AEP rainfall event.
- If the sediment retention pond is to remain online during a work stoppage and the contributing catchment is fully stabilised, ensure accumulated sediments have been removed and disconnect the T-bar decant to reduce the frequency of emergency spillway activation and consequent erosion.
- Where a primary spillway upstand riser is used, place the top of the riser a minimum 300mm lower than the emergency spillway crest. Ensure the riser and the discharge pipe connections are all completely watertight.
- Where possible, install the piping through the embankment as the embankment is being constructed.

9.1.4.12 Pipe Outlets

Lay the discharge pipe at a 1 – 2% gradient, compact the fill material around it using a machine compactor and incorporate anti-seep / filters collars with the following criteria:

- Anti-seep collars
 - Install collars around the pipe to increase the seepage length along the pipe with a spacing of approximately 10m;
 - The vertical projection of each collar is 1m; ensure all anti seep collars and their connections are watertight.
- Filter collars
 - The filter collar, as shown in figure 9-10 , should be positioned along the pipe ensuring they start just after half way through the dam where $h = 2/3 H$, where H is the embankment height.
 - The filter collar should be 1m x 1m x 1m and allow for sufficient compaction around the pipe. Specific design is required if the pipe diameter is greater than 200mm.
 - The filter material should be medium to coarse sand, e.g. a D15 = 0.7mm is anticipated to provide a good filter. Seek professional advice if there is any doubt about the compatibility of filter materials with the local ground conditions or embankment fill.
 - The filter sands should be compacted sufficiently wet to optimize compaction and avoid saturation collapse.
 - The filter drain should continue to the outlet to allow for drainage from the filter collar to the downstream toe.
 - The outlet should allow for seepage from the filter drain and be stabilized against erosion and dissipate energy, e.g. rock fill riprap at the outlet with a heavy-duty geotextile filter fabric.

9.1.5 Construction specifications

Sediment retention ponds have the following construction specifications:

- Before building a sediment retention pond, install sediment controls such as Silt Fences (section 9.2) below the construction area and maintain them to a functional standard until the sediment retention pond batters are fully stabilised in accordance with the practices outlined in section 9.3.
- Under areas of proposed fill, clear topsoil or other unsuitable material down to competent material. Large fill embankments may need to be keyed in.
- Use only approved fill.
- Place and compact fill in layers as per the engineer's specifications. In a number of instances (e.g. steep slopes and/or low strength soils) specific geotechnical design and certification will be required.
- Do not place pervious materials such as sand or gravel within the fill material.
- Construct fill embankments approximately 10% higher than the design height to allow for settlement of the material.
- Construct the emergency spillway.
- Install and stabilise the level spreader.
- Securely attach the decant system to the horizontal pipe work. Make all connections watertight. Place any manhole riser on a firm foundation of concrete (preferred) or impervious compacted soil.
- Do not place pervious material such as sand or scoria around the discharge pipe or the anti-seep collars/ filters.
- Protect inlet and outlet with suitable geotextile fabric.
- Provide an all-weather access track for maintenance.
- Check sediment retention pond freeboard and spillway elevations for differential settlement and rectify as necessary.
- Stabilise both internal and external batters with vegetation and the emergency spillway in accordance with the site's approved ESCP.
- Undertake an As-Built assessment at the completion of construction to check against the design. If there are any discrepancies rectify immediately.



Figure 9-11 Construction of a Sediment Retention Pond

9.1.6 Maintenance

Sediment retention ponds have the following maintenance requirements:

- Clean out sediment retention ponds before the volume of accumulated sediment reaches 20% of the forebay volume. To assist in gauging sediment loads, a staff height gauge will assist with knowing when this volume is achieved. If sediment accumulates within the main body of the SRP this will also need to be removed.
- Clean out sediment retention ponds with high capacity sludge pumps, or with excavators (long reach excavators if needed) loading onto sealed tip trucks or to a secure area onsite.

- The ESCP should identify disposal locations for the sediment removed from the sediment retention pond. Deposit the sediment in such a location so that it does not lead to a direct discharge to receiving environments. Stabilise all disposal sites as required and approved in the site's ESCP.
- Clean out the forebay as necessary to maintain maximum efficiency.
- Inspect sediment retention ponds every day and before every forecasted rainfall event.
- Inspect for correct operation after every runoff event and at intervals during any sustained rain event.
- Immediately repair any damage to sediment retention ponds caused by erosion or construction equipment.

9.1.7 Decommissioning

In decommissioning sediment retention ponds consider the following:

- Install a silt fence or other device below the sediment retention pond prior to decommissioning the pond.
- Take the pond offline (ie divert water away from pond inlet).
- Dewater the pond ensuring sediment laden water is treated appropriately.
- Remove and correctly dispose of all accumulated sediment. The methodology required for this will depend on the specific situation:
 - Removal can be done by leaving the sediments to dry and remove by digger or using a sucker truck while sediments are in a slurry form.
 - For ponds located near waterbodies, all accumulated sediments should be removed from the pond and buried away from any waterbodies in areas with low erosion risk to avoid the fine sediments being entrained in future storm events.
 - If sediments are to be left in place and buried, they can be stabilised using calcium hydroxide (slaked lime).
- Remove geotextile fabric, concrete, pipe and other construction materials.
- Backfill the pond and compact soil, re-grade as required or reform as permanent stormwater feature if this has been approved in plans.
- Stabilise all exposed surfaces.

9.2 Silt fences

9.2.1 Definition and purpose

A silt fence is a temporary barrier of woven geotextile fabric that is used to capture predominantly coarse sediments carried in sheet flow. Silt fences temporarily impound sediment laden runoff, reducing velocities and allowing sediment to settle out of the water.

The purpose of a silt fence is to detain flows from runoff so that deposition of transported sediment can occur through settlement.



Figure 9-12 Silt fence with returns to reduce lateral water movement

9.2.2 Conditions where practice applies

Silt fences apply when:

- Contributing catchments are less than 0.5ha. Above this careful consideration of design and alternative measures are required.
- Intercepting sheet flow.
- On low gradient sites for confined areas, such as short steep batter fills, house construction sites and along watercourses. (Do not install silt fences across watercourses or in areas of concentrated flows).
- To delineate the limit of disturbance on an earthworks site such as riparian areas or bush reserves.

9.2.3 Limitations

Silt fences have the following limitations:

- Silt fences do not capture many soil particles finer than 0.02mm in diameter (for example fine silts and clays) due to the short detention time of water behind the silt fence and relatively large pore size of most fabrics.
- The pores in the silt fence fabric become clogged relatively quickly with fine textured sediments, which result in the fabric becoming impermeable. As a result additional reinforcing (such as chain link fence – super silt fence refer section 9.3 might be required).
- Relative to other measures they can be high cost.
- Only used for sheet flow, not concentrated flow. Do not use silt fences as checks dams in channels (to reduce velocities) or place them where they will intercept concentrated flow.
- Silt fences should be used a part of a treatment train approach.

9.2.4 Key design criteria

Design Silt fences using the criteria below:

- Ensure silt fence height is a minimum 400mm above ground level.
- Place supporting posts/waratahs for silt fences no more than 2 metres apart unless additional support is provided by tensioned wire (2.5mm HT) along the top of the silt fence. Ensure supporting posts/waratahs are embedded a minimum of 400 mm into the ground.
- Where a strong woven fabric is used in conjunction with a wire support, the distance between supporting posts can be extended up to 4 metres. Double the silt fence fabric over and fasten to the wire and posts with wire ties or cloth fastening clips at 150mm spacings.
- Always install silt fences along the contour. Where this is not possible or where there are long sections of silt fence, install short silt fence returns (refer Figure 9-13 projecting upslope from the silt fence to minimise concentration of flows. Silt fence returns should be a minimum 2 metres in length, can incorporate a tie back and are generally constructed by continuing the silt fence around the return and doubling back, eliminating joins.
- Join lengths of silt fence by doubling over fabric ends around a wooden post or batten or by stapling the fabric ends to a batten and butting the two battens together (refer Figure 9-13).
- Install silt fence wings at either end of the silt fence projecting upslope to a sufficient height to prevent outflanking.
- Where impounded flow may overtop the silt fence, crossing natural depressions or low points, make provision for a riprap splash pad or other outlet protection device.
- Maximum slope lengths, spacing of returns and angles for silt fences are shown in Table 9-1.

Table 9-1 Silt fence design criteria

Slope steepness %	Slope length (m) (Maximum)	Spacing of returns (m)	Silt fence length (m) (Maximum)
Flatter than 2%	Unlimited	N/A	Unlimited
2 – 10%	40	60	300
10 – 20%	30	50	230
20 – 33%	20	40	150
33 – 50%	15	30	75
> 50%	6	20	40

- Where water may pond regularly behind the silt fence, provide extra support for the silt fence with tie backs from the silt fence to a central stable point on the upward side. Extra support can also be provided by stringing wire between support stakes and connecting the filter fabric to this wire.
- The geotextile fabric cloth should be appropriate for purpose (including strength and opening size) and installed following the manufacturer's specifications.

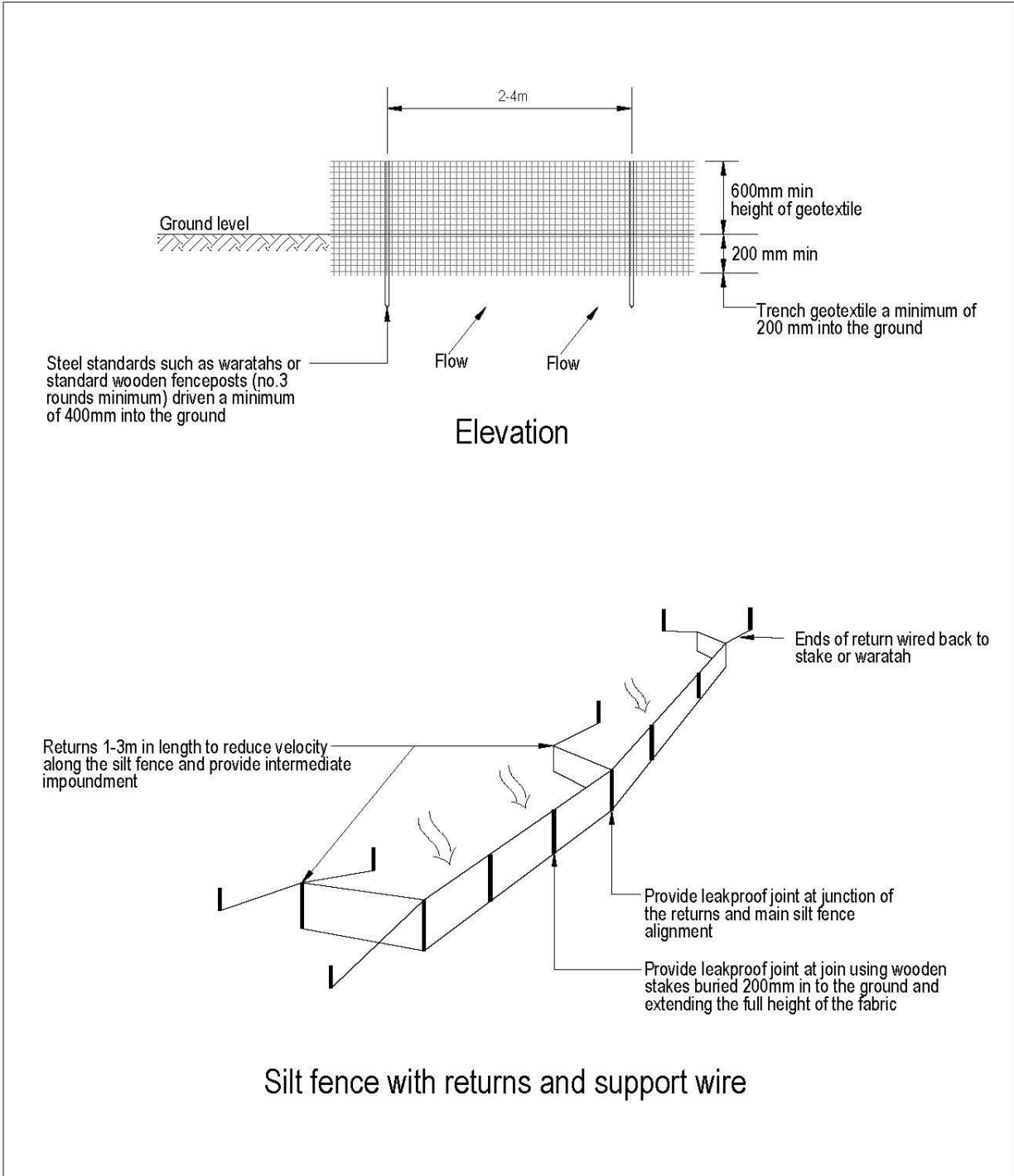
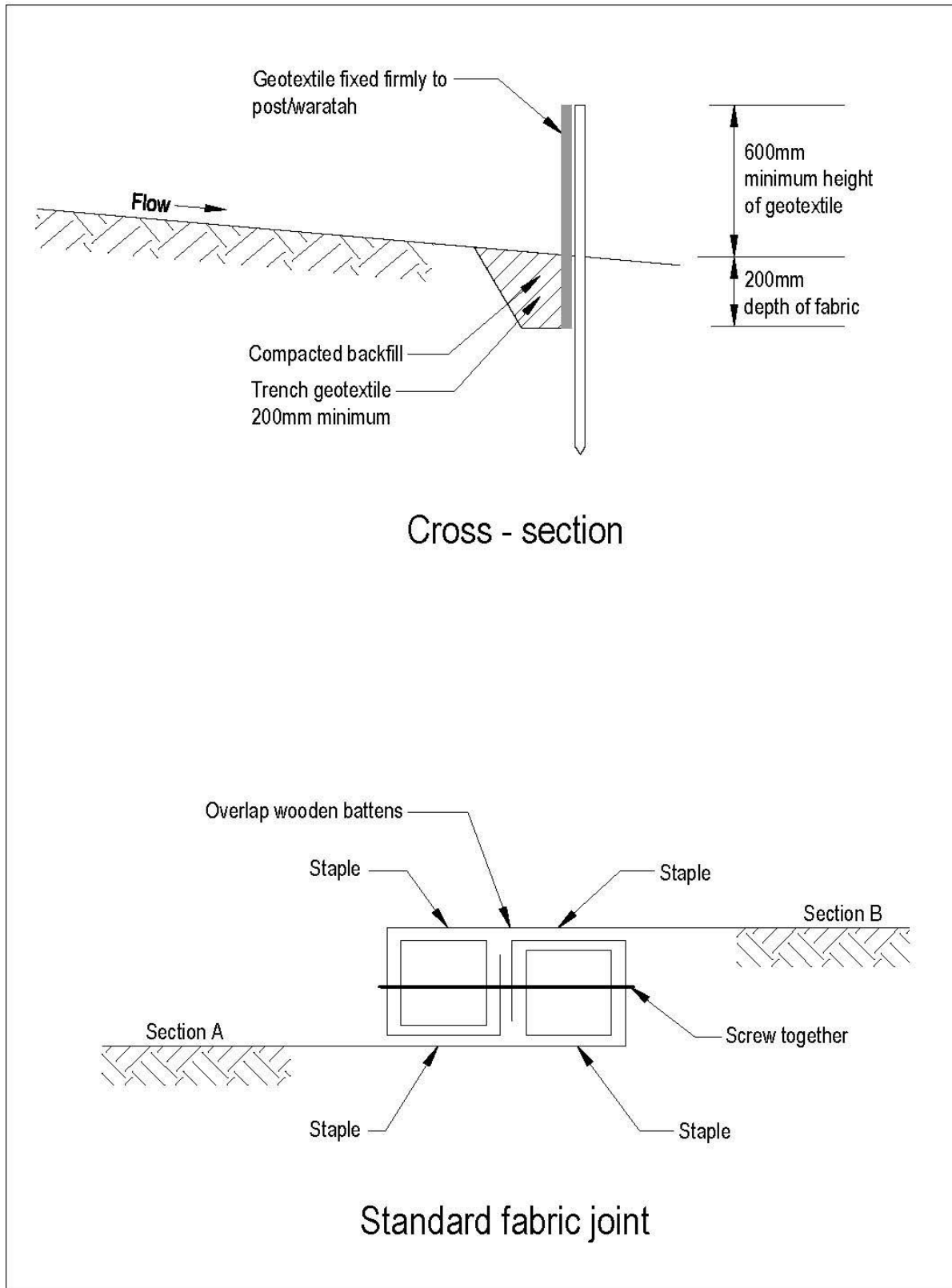
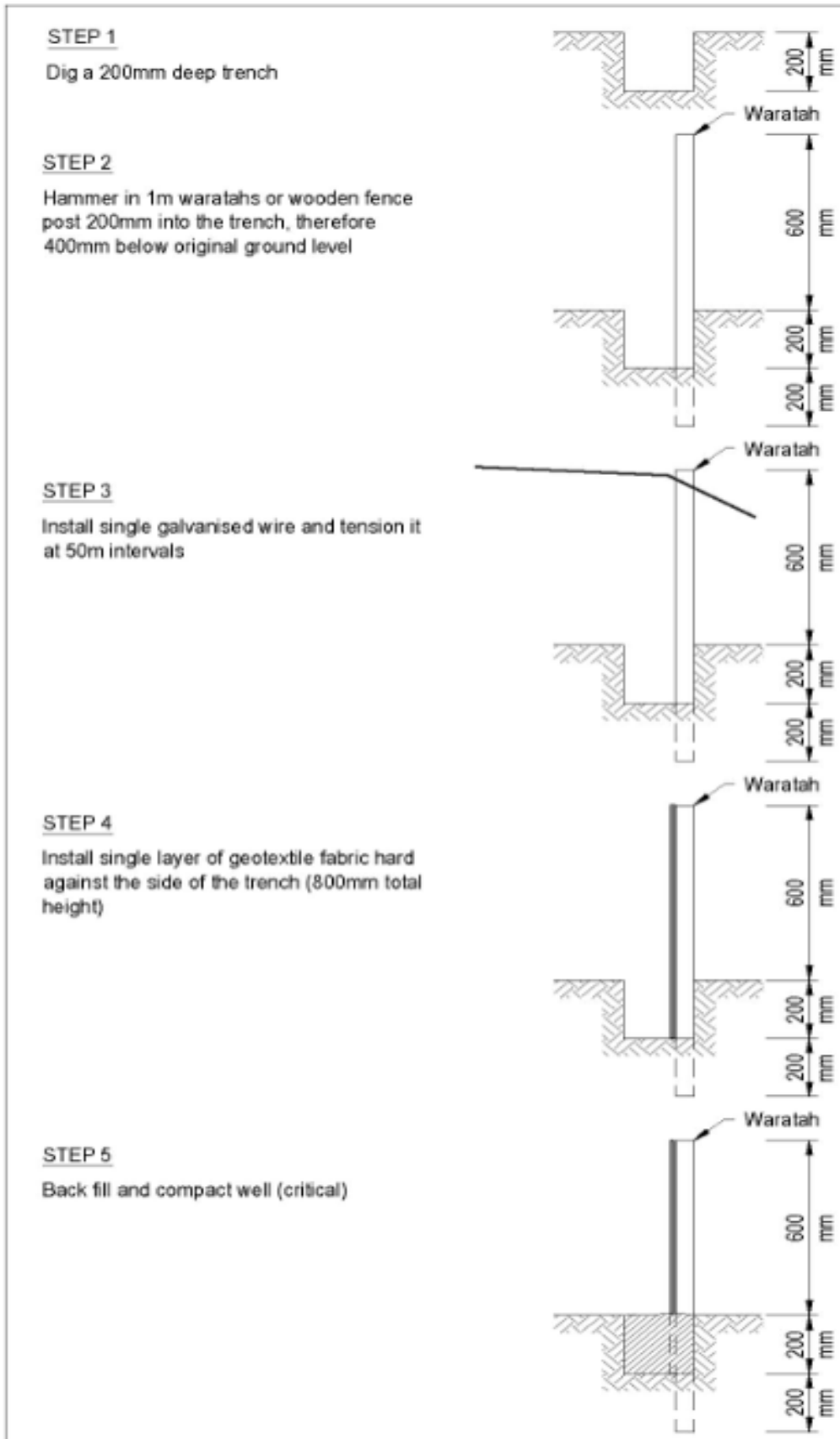

Figure 9-13 Schematic of a Silt Fence





9.2.5 Construction

When constructing a silt fence, apply the following:

- Use silt fence material appropriate to the site conditions and in accordance with the manufacturers' specifications.
- Always install silt fences along the contour.
- Excavate a trench a minimum of 100mm wide and 200mm deep along the proposed line of the silt fence.
- Improve by adding a 200mm fence return at right angles on the base towards the direction of the flow this strengthens the fences it is currently not shown on the diagrams.
- Use supporting posts of tanalised timber a minimum of 50mm square, or steel waratahs at least 0.8m in length.
- Ensure the posts are driven to a depth of at least 400mm.
- Install the support posts/waratahs on the downslope edge of the trench and silt fence fabric on the upslope side of the support posts/waratahs to the full depth of the trench, then backfill the trench with compacted soil.
- If required reinforce the top of the silt fence fabric with a support made of high tensile 2.5mm diameter galvanised wire. Tension the wire using permanent wire strainers attached to angled waratahs at the end of the silt fence.
- Where ends of silt fence fabric come together, ensure they are overlapped, folded and stapled/screwed to prevent sediment bypass.

9.2.6 Maintenance

Silt fences require the following maintenance:

- Inspect silt fences at least once a week and after each rainfall.
- Check for damage including rips, tears, bulges in the fabric, broken support wires, loose posts/waratahs, overtopping, outflanking, undercutting, and leaking joints in fabric.
- Make any necessary repairs as soon as identified. Tears in silt fences need to be fixed as per Standard Fabric Joint as above.
- Remove sediment when bulges occur or when sediment accumulation reaches 20% of the fabric height.
- Remove sediment deposits as necessary (prior to 20% of fabric height) to continue to allow for adequate sediment storage and reduce pressure on the silt fence.
- Dispose of sediment to a secure area to ensure that it does not discharge to the receiving environment.

9.2.7 Decommissioning

In decommissioning silt fences consider the following:

- Do not remove silt fence until the catchment area has been appropriately stabilised.
- Remove and dispose of accumulated sediment to an appropriate location.
- Backfill trench, re-grade and stabilise the disturbed area.

9.3 Super silt fence

9.3.1 Definition and purpose

A super silt fence is a temporary barrier of woven geotextile fabric over a chain link fence that is used to capture predominantly coarse sediments carried in sheet flow.

Super silt fences temporarily impound sediment laden runoff, reducing velocities and allowing sediment to settle out of the water.

The purpose of a super silt fence is to detain flows from runoff so that deposition of transported sediment can occur through settlement.

9.3.2 Conditions where practice applies

Super silt fences apply:

- Where debris or sediment volumes are likely to exceed the capacity for standard silt fences
- Where contributing catchments are less than 0.5ha. Above this careful consideration of design and alternative measures is required
- A barrier is needed to collect and hold debris and soil, preventing the material from entering critical areas, watercourses and streets.
- Can be used where the installation of an earth or topsoil bund would destroy sensitive areas such as bush and wetlands.
- Should be placed as close to the contour as possible. No section of the fence should exceed a grade of 5% (20:1, 2.86°) for a distance of more than 15m.

9.3.3 Limitations

Super silt fences have the following limitations:

- Super silt fences do not capture many soil particles finer than 0.02mm in diameter (for example fine silts and clays) due to the short detention time of water behind the super silt fence and relatively large pore size of most fabrics.
- The pores in the super silt fence fabric become clogged relatively quickly with fine textured sediments, which result in the fabric becoming impermeable.
- Relative to other measures they can have a high cost.
- Only used for sheet flow, not concentrated flow. Do not use super silt fences as checks dams in channels (to reduce velocities) or place them where they will intercept concentrated flow.
- Super silt fences should be used a part of a treatment train approach.



Figure 9-14 Super Silt Fence

9.3.4 Key design criteria

Design Super Silt fences using the criteria below:

- When considering super silt fence installation for larger catchments (greater than 0.5ha), carefully consider the specific site conditions and other alternative control measures available.
- Limits imposed by ultraviolet light affect the stability of the fabric and will dictate the maximum period that the super silt fence may be used.
- Where ends of the geotextile fabric come together, overlap, fold and staple the fabric ends to prevent sediment bypass (refer Figure 9-15).
- Base the length of the super silt fence on the limits shown in Table 9-2.
- Improve by adding a 200mm fence return at right angles on the base towards the direction of the flow this strengthens the fences it is currently not shown on the diagrams.

Table 9-2 Super silt fence design criteria

Slope steepness %	Slope length (m) (Maximum)	Super silt fence length (m) (Maximum)
0 – 10%	Unlimited	Unlimited
10 – 20%	60	450
20 – 33%	30	300
33 – 50%	30	150
> 50%	N/A	N/A

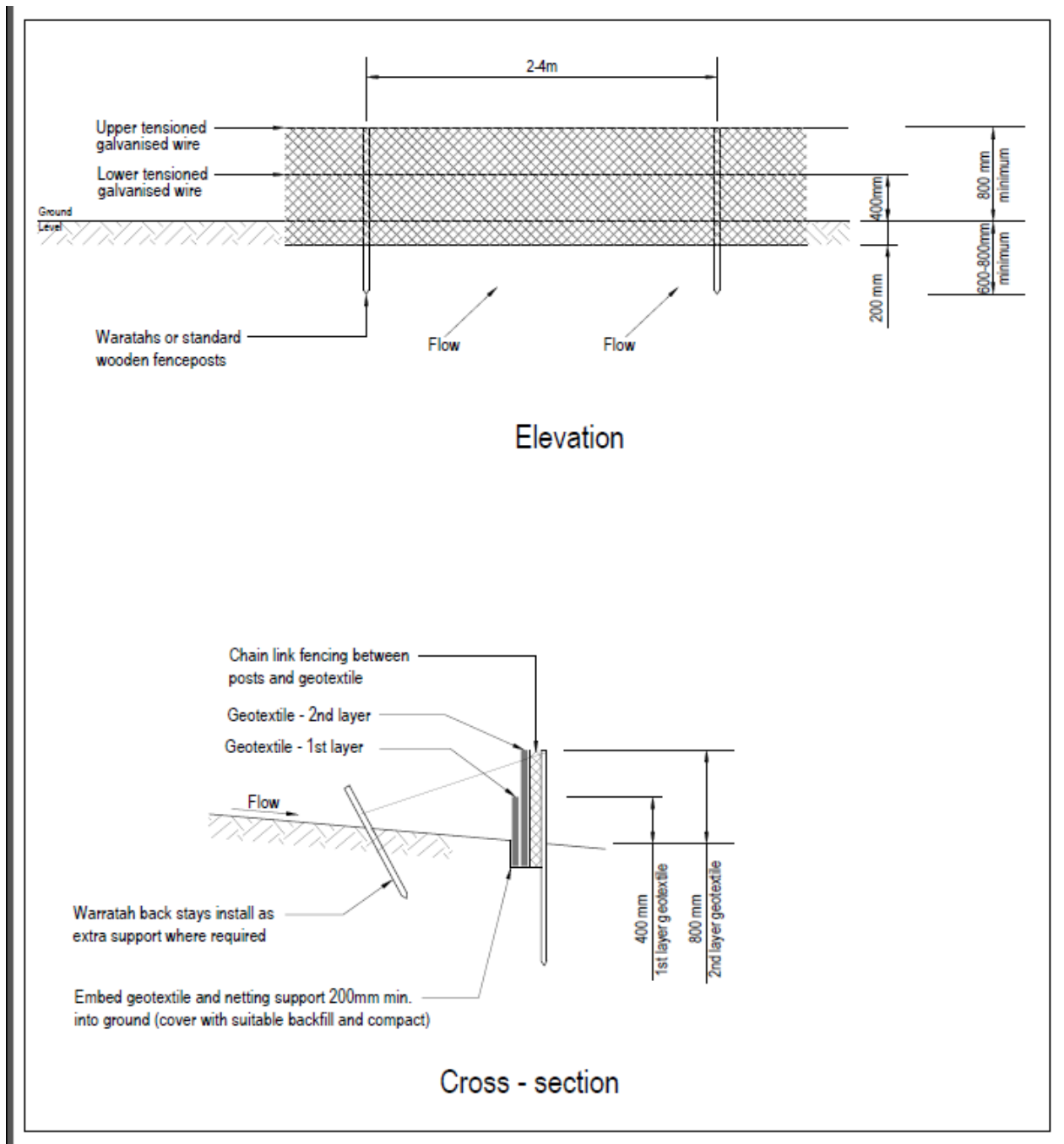
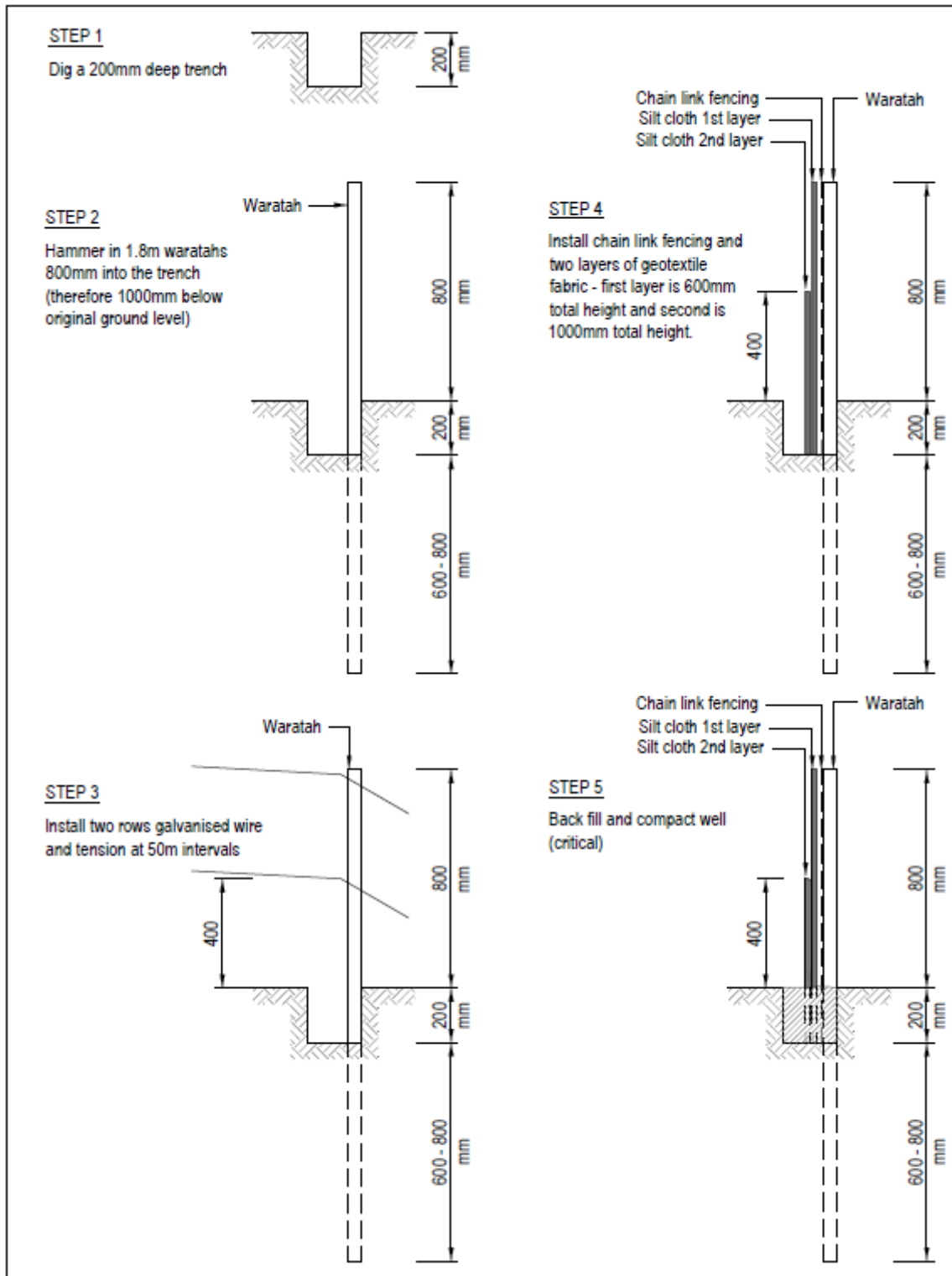

Figure 9-15 Schematic of a Super Silt Fence



- The geotextile fabric cloth should be appropriate for purpose (including strength and opening size) and installed following the manufacturer's specifications.

9.3.5 Construction

When constructing a super silt fence, apply the following:

- Use super silt fence material appropriate to the site conditions and in accordance with the manufacturers' specifications.
- Always install super silt fences along the contour.
- Excavate a trench a minimum of 100mm wide and 200mm deep along the proposed line of the super silt fence.
- Use supporting posts of tanalised timber (No. 3 rounds, No. 2 half rounds), or steel waratahs at least 1.8m in length.
- While there is no need to set the posts in concrete, ensure the 1.8m long posts are driven to a depth of 1metre.
- Install tensioned galvanised wire (2.5 mm HT) at 400mm and again at 800mm above ground. Tension the wire using permanent wire strainers attached to angled waratahs at the end of the super silt fence.
- Secure chain link fence to the fence posts with wire ties or staples, ensuring the chain link fence goes to the base of the trench.
- Fasten two layers of geotextile fabric securely to the super silt fence with ties spaced every 60cm at the top and mid-section of the super silt fence.
- Place the two layers of geotextile fabric to the base of the trench (a minimum of 200mm into the ground and 200mm upslope) and place compacted backfill back to the original ground level.
- When two sections of geotextile fabric adjoin each other, ensure they are doubled over a minimum of 300mm, wrapped around a batten and fastened at 75mm spacings to prevent sediment bypass.

9.3.6 Maintenance

Super silt fences require the following maintenance:

- Inspect super silt fences at least once a week and after each runoff event.
- Check for damage including rips, tears, bulges in the fabric, broken support wires, loose posts/waratahs, overtopping, outflanking, undercutting, and leaking joins in fabric.
- Make any necessary repairs as soon as identified.
- Remove sediment when bulges occur or when sediment accumulation reaches 20% of the fabric height.
- Remove sediment deposits as necessary (prior to 20% of fabric height) to continue to allow for adequate sediment storage and reduce pressure on the super silt fence.
- Dispose of sediment to a secure area to ensure that it does not discharge to the receiving environment.

9.3.7 Decommissioning

In decommissioning super silt fences consider the following:

- Do not remove the super silt fence until the catchment area has been appropriately stabilised.
- Remove and dispose of accumulated sediment to an appropriate location.
- Backfill trench, re-grade and stabilise the disturbed area.

9.4 Decanting earth bund

9.4.1 Definition and purpose

Decanting earth bunds are designed as a miniature SRPs for smaller catchment areas.

The purpose of a decanting earth bund is to intercept sediment laden runoff and reduce the amount of sediment leaving the site by incorporating a device to dewater the bunded area at a rate that will allow suspended sediment to settle out before runoff is discharged.



Figure 9-16 Decanting Earth Bund

9.4.2 Conditions where practice applies

Decanting earth bunds can be constructed:

- On small sites where contributing catchment sizes and available area make sediment detention ponds impractical.
- For controlling runoff from small areas (less than 0.3ha) that are isolated from the main site controls because of site layout or because of site infrastructure, such as roading or drainage, restricting flow to the main site controls.

9.4.3 Limitations

Decanting earth bunds have the following limitations:

- Decanting earth bunds capture and treat slightly finer soil particles than silt fences but are not as effective in sediment removal as sediment retention ponds.
- Short circuiting can occur because they generally do not have a defined inlet.
- They are usually more effective on flatter slopes where runoff velocities are less.
- Recommended maximum catchment of 0.3ha.

9.4.4 Key design criteria

When designing decanting earth bunds consider the following criteria:

- Decanting earth bunds need a constructed outlet structure and emergency spillway as designed for sediment retention ponds (refer section 9.1.4).
- Floating decants must be installed on all DEBs.
- Decanting earth bund volumes are sized in accordance with the methodology outlined in Appendix 13.5.
- The impoundment area of the decanting earth bund is to be level and have a length to width ratio for the main inflows of between 3:1 and 5:1. A diversion bund may be required to achieve this.
- The maximum height of the decanting earth bund to the invert of the spillway should be 1 metre.
- The decanting earth bund is to have a minimum base width of 3 metres and a maximum batter grade of 1:1.
- Particular attention needs to be given to soil type, and need for the design and installation of an anti-seep or filter collar (refer pond design section 9.1.4).

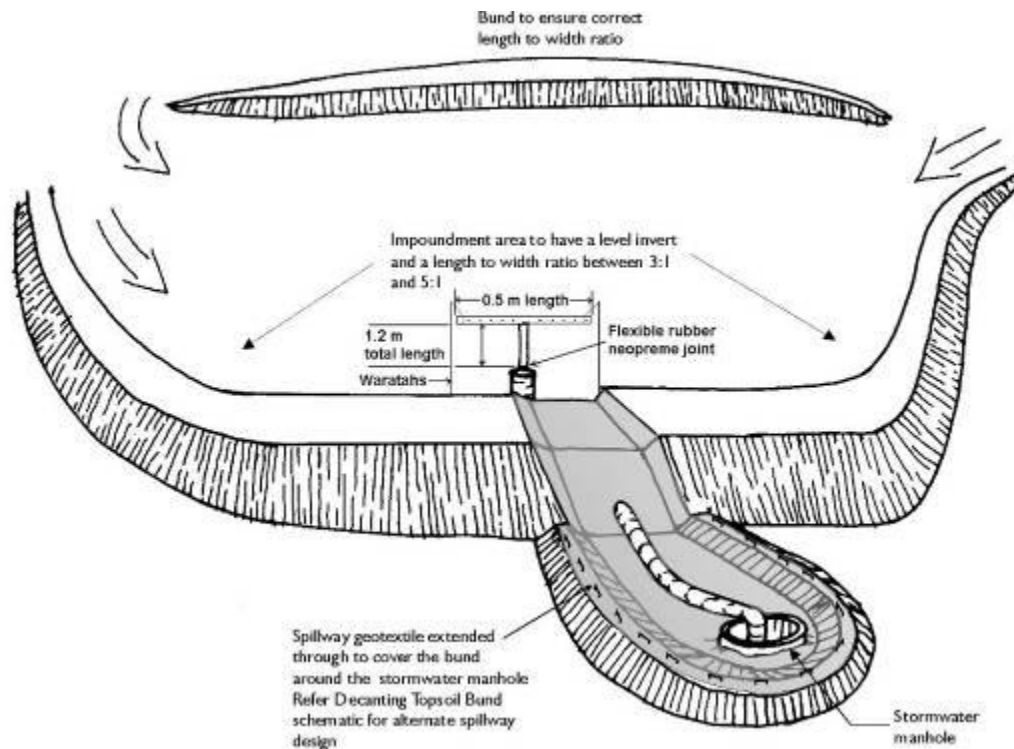

Figure 9-17 Decanting Earth Bund with a Floating Decant

9.4.5 Construction

Consider the following when constructing decanting earth bunds:

- Build decanting earth bunds along the contour to obtain required volumes.
- Remove all organic material and vegetation before construction.
- The decanting earth bund is to be keyed into the existing ground to a minimum depth of 0.3 metres.
- The decanting earth bund is to be made with a clay-silt mix of suitable moisture content to achieve a reasonable compaction standard (90%). It is considered that this can be achieved, in most instances, by track rolling over 150 - 200 mm layers. Particular care is required to achieve good compaction around the outlet pipe that passes through the bund to avoid seepage and potential failure.
- Install a 150 mm diameter non-perforated outlet pipe through the bund. This is to discharge to a stable erosion-protected area or stormwater system.
- A T-Bar decant should be a 100mm diameter PVC pipe, 0.5 metres long with 20 equally spaced holes of 10mm diameter to achieve a discharge rate of 3 litres/sec/ha of contributing catchment.
- A sealed PVC pipe (with endcaps) is placed on top of the decant to provide buoyancy.



Figure 9-18 Floating Decant in DEB

Use a flexible thick rubber coupling to provide a connection between the decant arm and the discharge pipe. To provide sufficient flexibility where needed, install two couplings. Fasten the flexible coupling using strap clamps, glue and screws.

- The decant is fastened to two waratahs by way of a nylon cord to the correct height.
- Provide an emergency spillway to a stabilised outfall 150mm above the level of the top of the decanting pipe. This can be a trapezoidal spillway with a minimum invert length of 2 metres which is smooth, has no voids and is lined with a soft needle punched geotextile to the stabilised outfall. Ensure the geotextile is pinned at 0.5 metre centres.
- The emergency spillway is to have a minimum freeboard of 250mm, i.e. between the invert of the spillway to the lowest point of the top of the bund.
- Undertake an As-Built assessment at the completion of construction to check against design. If there are any discrepancies rectify immediately.

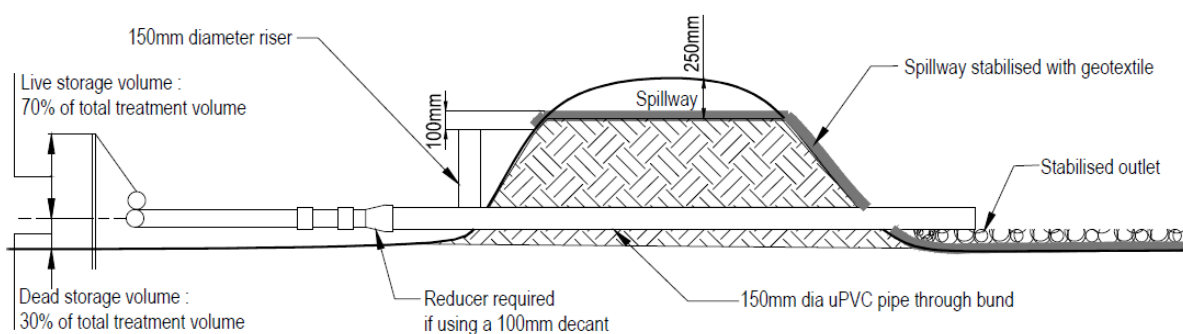

Cross - section

Figure 9-19 Cross-section Decanting earth bund

9.4.6 Maintenance

Decanting earth bunds require the following maintenance requirements:

- Inspect decanting earth bunds at least once a week and after each runoff event.
- Check for damage including:
 - Spillway is secure and functional
 - Erosion at outlet, remedy if required or look at diverting outlet
 - Damage to decant and fittings
 - Seepage through embankment, or along outlet pipe
 - Blockages to holes in decants.
- Make any necessary repairs as soon as identified.
- Remove sediment when sediment accumulation reaches 20% of banded volume.
- Dispose of removed sediment to a secure area to ensure that it does not discharge back into the decanting earth bund or to the receiving environment.

9.4.7 Decommissioning

Consider the following when decommissioning decanting earth bunds:

- Do not remove decanting earth bund until the catchment area has been appropriately stabilised.
- Refer to section 9.6 for dewatering.

- Remove and dispose of accumulated sediment to an appropriate location.
- Remove pipes, fabric and other construction materials.
- Backfill, re-grade and stabilise the disturbed area.

9.5 Flocculation

9.5.1 Definition and purpose

Flocculation is a method of enhancing the settlement of suspended sediment from earthworks runoff and is typically used in conjunction with sediment retention ponds or decanting earth bunds.

The flocculant neutralises the electrical charge that cause individual sediment particles to repel each other. The sediment particles clump together with the flocculant, and these larger particles then settle out.

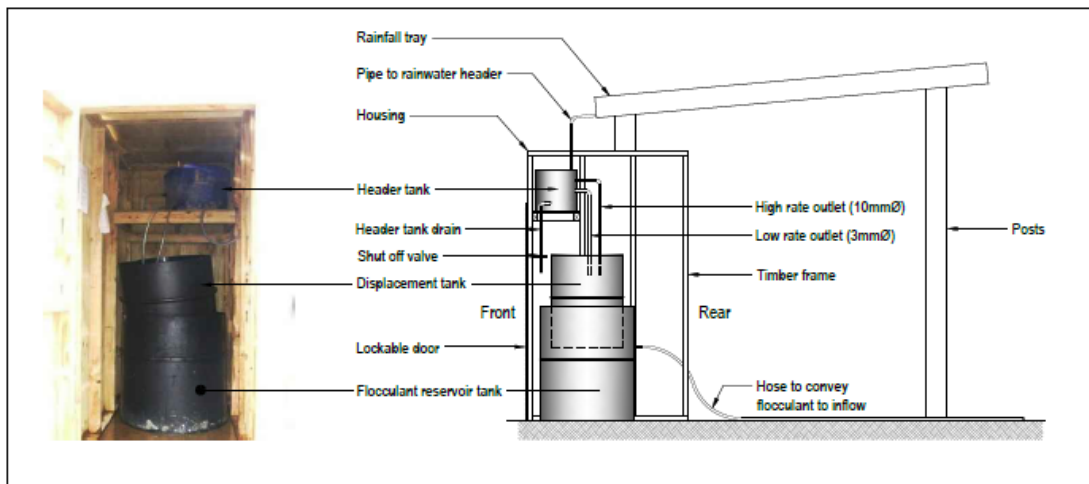

Figure 9-20 Rain Activated Flocculant Dosing System (Auckland Council)

The purpose of flocculation is:

- To treat sediment laden runoff to an extent greater than standard sediment control practices; and
- To reduce the volume of sediment leaving a site, protecting sensitive downstream environments from excessive sedimentation and water quality degradation.

In a number of environments and soil types, flocculation is the only method that will remove fine suspended (colloidal) material from runoff.

9.5.2 Conditions where the practice applies

Flocculation is used to enhance the retention of sediment on earthworks sites:

- Where there are potential adverse effects on sensitive receiving environments resulting from sediment discharge (flocculation also needs to be carefully managed to ensure acidic discharges of excess flocculant do not occur).
- Where clay and/or silt soils (particle size < 0.005mm) are present. In Tasman district, land disturbance within Moutere Gravels, or other soils with significant clay components, flocculation will be needed to achieve effective sediment retention.
- Where site constraints prevent sediment retention ponds being designed or constructed to the required shape or volume specifications.
- Where sediment retention ponds are not performing adequately.
- In areas with highly erodible soils or very steep or long slopes, which may have high sediment yields during runoff events.
- On earthworks sites with repeated machinery movements (for example on haul roads) which can result in high sediment loadings in stormwater.

9.5.3 Limitations

Flocculation has the following limitations:

- Dependent on the flocculant used, flocculation generally works on clay and silt soils (particle size < 0.005mm) but is less effective on other soil types.
- Flocculation requires specialist expertise and a high degree of monitoring and maintenance.
- Liquid flocculant dosing systems need regular monitoring to ensure they do not run out of chemical during rainfall events and that pH levels remain within acceptable ranges (ie pH6.5-8.0). Dosing should cease if the pH drops below 5.5 or rises above 8.5.
- Spills of flocculant can have adverse effects on the receiving environment and careful onsite management and appropriate staff training is required.
- Resource consent or authorisation as a condition of consent is required for the use of flocculants

9.5.4 Key design criteria

9.5.4.1 Desired Outcomes

Flocculation systems should be designed and managed to achieve the following outcomes:

- Consistently high removal of suspended sediments from runoff for events up to the design event for the sediment retention pond or decanting earth bund.
- No overdosing of ponds and no release of excess flocculant or low pH water (less than 5.5 pH units) to receiving environments.
- Dosing only once flow into the pond has commenced.
- Sufficient flocculation capacity to treat events up to the design storm volume (whether this is achieved through system capacity or an appropriate maintenance regime – eg topping up systems before and during events).
- No spills of flocculant.

Flocculation is a specialist activity requiring management by suitably qualified personnel. Only experienced contractors should be used.

9.5.4.2 Flocculant Type

There are a variety of flocculants available on the market, and many are available in both a solid and liquid form.

Solid flocculants are used as blocks or pellets and may come in socks or bags that are placed directly in areas of concentrated flows upstream of settlement areas.

Liquid flocculants are used in conjunction with sediment ponds and a dosing system is used to ensure the appropriate amount of flocculant is released to match the volume of runoff to be treated.

The flocculant type typically used is liquid Polyaluminium Chloride (PAC). Alternative flocculants will require specific approval from the Council prior to use.

Tests using soils from the site, or from a site that has similar soil characteristics, will be needed to determine the most appropriate flocculant type and the optimal dosing rate required (ie to determine the volume of runoff from your site that 1 litre of your selected flocculant will treat).

In all cases flocculants are to be used to the manufacturer's specifications. Different flocculants can contain different levels of active ingredient and it is vital that the design of the liquid dosing system or installation method for solid flocculants reflects the particular flocculant to be used. Changes to the flocculant type or brand may require review and amendment to the dosing system or installation method.

9.5.4.3 Flocculation Plan

If using flocculation, a Flocculation Plan should be provided to Council which includes the following as a minimum:

- Name, contact details and qualification/experience of flocculation provider.
- Flocculant type to be used including:
 - Active ingredients and their concentrations
 - Dosing rate applicable to the site soils (including lab results)
- Methodology for distribution or dosing of flocculant, including an outline of any changing flocculation needs as works progress and disturbed areas are stabilised.
- Design details of any liquid flocculant dosing system, including tank and hose sizes and dosing point location.
- Monitoring and maintenance plan (which reflects local rainfall characteristics).
- Contingency planning in the event of a flocculant spill.
- Relevant resource consent details.

Further information on dosing system design and flocculation is available in Auckland Council's Technical Publication 227 "*The Use of Flocculants and Coagulants to Aid the Settlement of Suspended Sediment in Earthworks Runoff : Trials, Methodology and Design [draft]*" June 2004.

9.5.4.4 Monitoring and adjusting for changing site conditions

Each new flocculant treatment system needs to be monitored carefully during the first few rainfall events to check that the system is effective, and to ensure that under or overdosing is not occurring.

If overdosing is suspected because the pond dead storage water is exceptionally clear, samples should be taken from the pond for pH testing. The dosing regime should be adjusted depending on the outcome of these results.

The dosing system may require modification if earthworks alter the extent of the contributing catchment or the quality of stormwater runoff is improving because of stabilisation of the site. Failure to do so will cause either under or overdosing of flows entering the sediment retention pond.

9.5.4.5 Flocculant spill management

- There should be earth bunds around the flocculation and refilling station to contain any spills of flocculant. If there is a spill of flocculant onto the ground it should be immediately contained to prevent it entering water. The spilt flocculant should be recovered if possible and placed in polyethylene

containers. If the spilt flocculant cannot be recovered, it should be mixed with a sufficient volume of soil to neutralise the flocculant (eg at least ten times the volume of spilt flocculant). The soil with which the flocculant has been mixed should be buried a minimum of 0.5 metres below the surface.

- If there is a spill of flocculant into ponded water, discharge from the pond to natural water (streams, rivers, lakes, wetlands, etc) should be prevented.
- If there is a spill of flocculant into flowing water:
 - The Tasman District Council should be advised immediately
 - Any further discharge of flocculant into the water should be prevented
 - The volume of the spill should be recorded
 - If possible, the water and spilt flocculant should be pumped into a bund or pond until all the spilt flocculant has been removed from the watercourse
 - Any downstream users should be identified and advised as soon as possible, especially if the flocculant cannot be removed from the watercourse.

9.5.5 Decommissioning

When decommissioning flocculation systems remove all components of the flocculation shed. Equipment can be stored for future use on another pond.

Pond sediments will include flocculant bound in the settled sediments. These need to be disposed of to an appropriate location (refer section 9.1.7).

9.6 Dewatering

9.6.1 Definition and purpose

Dewatering is the removal of water from excavations and trenches. Dewatering is generally done by pumping and the resulting water should be discharged through a sediment retention device, such as a sediment sump (refer 9.5.5), dewatering sock, bag or similar device (eg modified skip bin, Figure 9-21).

Under no circumstances is sediment laden water to be discharged directly to roads, stormwater, waterways or areas that may flow into receiving environments, without adequate treatment to retain sediments.

In some situations sediment laden water may be dewatered to a soakage pit provided there are no other contaminants in the water, the pit has sufficient drainage capacity and it is not located near a waterbody or bore or where there is a risk of channel migration or erosion.

9.6.2 Conditions where practice applies

Dewatering devices are used to dewater trenches and excavations during construction.

9.6.3 Limitations

- Pumping can resuspend sediment requiring an additional chamber for settling.
- Sufficient time for adequate settling may be difficult to achieve.

Always try to minimise the volume of water that requires dewatering, such as limiting length of open trench or providing diversions above excavations.

9.6.4 Key design criteria

To dewater, consider the following options:

- Minimising the volume of water and the levels of sediment.
- Retaining sediment laden water on site and maximising the settling of sediment on site (settling may be aided by the addition of flocculant, refer section 9.5).
- Always dewater the cleaner water at the top first.
- Residual sediment laden water can be pumped to a tank or truck and used as a dust suppressant.
- Smaller volumes of sediment laden water can be pumped to specially designed settling tanks (eg modified skip bins) or dewatering bags/socks. These are particularly useful on small sites such as for house construction where land area is limited.
- If utilising dewatering bags or socks give consideration to their removal when full as they may weigh a considerable amount.



Figure 9-21 Modified Skip Bin for Dewatering

- Small volumes of sediment laden water can also be pumped to a decanting earth bund, however care needs to be taken to ensure that these devices are not overwhelmed and that fine sediments are adequately trapped.
- Larger volumes can be pumped to a sediment retention pond. Always pump to the forebay.

9.6.5 Maintenance and Decommissioning

Regularly check dewatering tanks, socks and bags for remaining capacity and for damage (rips, tears, leaking joints, etc) and repair/ replace or empty as necessary to ensure ongoing sediment retention.

Dispose of collected sediment and used socks or bags to an appropriate location to ensure that sediment does not discharge to the receiving environment.

9.7 Sediment Sump

9.7.1 Definition and Purpose

Sediment sumps are temporary pits which trap and filter sediment-laden water from areas of excavation, or areas where water cannot drain by other means, before it is pumped to a suitable discharge area.

9.7.2 Conditions where practice applies

When water collects during the excavation phase of construction.

- Particularly useful in urban areas during excavation for building foundations.
- May also be used to dewater sediment retention measures.

9.7.3 Limitations

Always try to minimise the volume of water that requires drainage through the sediment sump for example providing clean water diversions up slope around excavations.

9.7.4 Key Design and Construction Criteria

The design is based on a perforated vertical standpipe placed in the centre of a pit which is then backfilled with aggregate.

- Determine the number of sediment sumps and their locations on site in accordance with the required dewatering facilities.
- Sediment sump dimensions are variable, but require a minimum depth of 1m and a minimum volume of 2m³.
- Construct the standpipe from 300 – 600mm diameter pipe with a grid of 10 mm diameter perforations at 60mm spacings along the standpipe. For a 1m deep sump the standpipe will need to be 1m long.



Figure 9-22 Dewatering Pipe Sock and Bag

- If the water is to be pumped directly to a receiving environment, then wrap geotextile fabric around the standpipe to help achieve a clean water discharge. When geotextile fabric is used, the surface area of the standpipe will need to be increased and the pumping rate decreased to prevent the geotextile becoming rapidly blocked.
- Place a base of 50mm sized aggregate in the sediment sump to a depth of 300mm.
- Place the standpipe in position so that it extends 300mm above the outer edge of the sediment sump.
- Backfill the sump area with 50mm sized aggregate so that the aggregate level at the standpipe extends 100 mm above the anticipated standing water elevation (refer Figure 9-23).
- Pump water from the centre of the standpipe to a suitable discharge area.
- Direct the discharge to an appropriate outlet.

9.7.5 Maintenance

Undertake ongoing checks throughout the use of the Sediment Sump to ensure effective operation. Regularly check sumps for remaining capacity and repair/ replace as necessary to ensure ongoing sediment retention.

Dispose of collected sediment to an appropriate location to ensure that sediment does not discharge to the receiving environment.

9.7.6 Decommissioning

In decommissioning sediment sumps consider the following:

- Install a silt fence or other device below the sump prior to decommissioning.
- Dewater sump.
- Remove and correctly dispose of all accumulated sediment and aggregate.
- Remove sump construction materials.
- Backfill the sump and compact soil, re-grade as required.
- Stabilise all exposed surfaces.

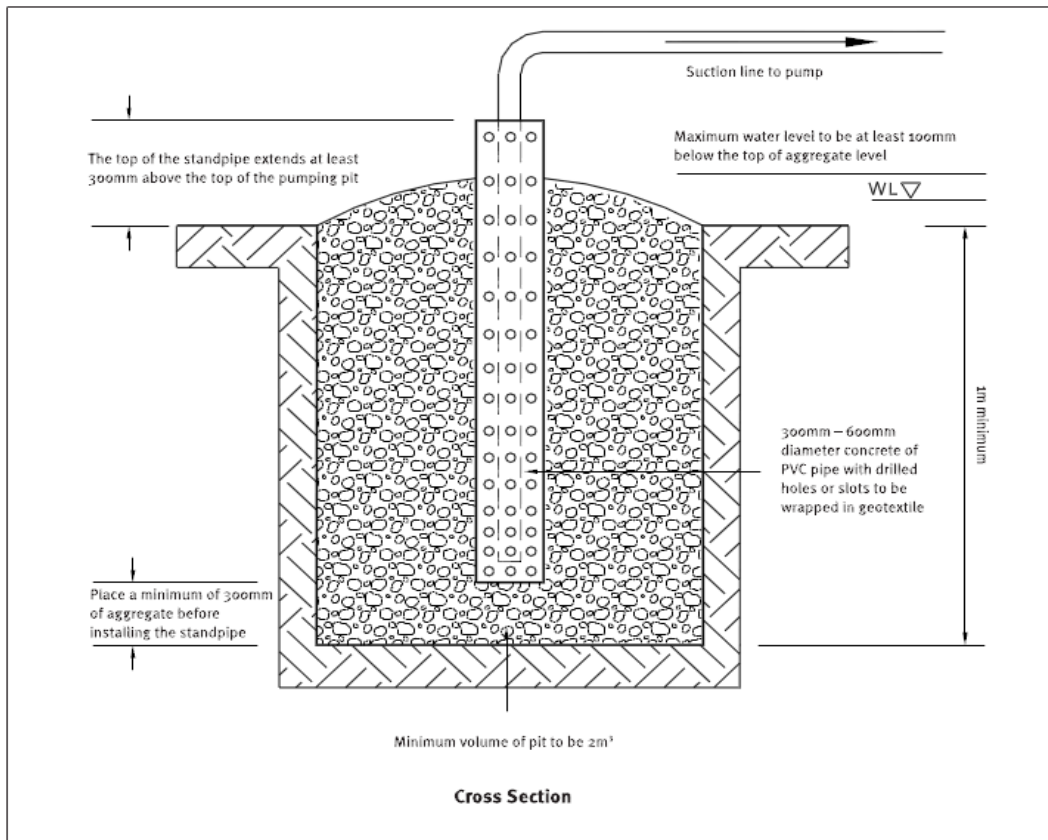

Figure 9-23 Sediment Sump (source ARC TP90 1999)

9.8 Stormwater inlet protection

9.8.1 Definition and purpose

Stormwater inlet protection is a barrier across or around a stormwater inlet (cesspit/sump). It is used to intercept and filter runoff carrying sediment or other contaminants before it enters a reticulated stormwater system, thereby preventing sediment-laden flows affecting infrastructure or entering receiving environments. The protection may take various forms depending upon the type of inlet to be protected and the potential for non-sediment contaminants (refer Chapter 10) to be present in runoff.

Stormwater inlet protection is a secondary sediment control device and should not be used as a standalone primary device. It should only be used in conjunction with other erosion and sediment control measures.

Stormwater inlet protection can also help delineate the location of stormwater inlets, allowing contractors to avoid vehicle movements, storage of materials and undertaking high risk activities (eg refuelling) in or near these areas.



Figure 9-24 Stormwater Inlet Protection – silt fence and geotextile sock

9.8.2 Conditions where practice applies

Stormwater inlet protection is suitable for small, low-gradient catchments (< 0.25ha, with slopes < 5%) as a component of a broader erosion and sediment control system.

Use stormwater inlet sediment control devices as an integral component of a much broader and more comprehensive erosion and sediment control system.

9.8.3 Limitations

Stormwater inlet protection has the following limitations:

- Only to be used in very small catchments (< 0.25ha).
- Not to be used as a standalone treatment device. They have relatively low sediment removal efficiency and should be used a part of a treatment train approach.
- High maintenance requirements, as there is a potential for reduced hydraulic efficiency and blockage - and therefore increased risk of bypass to downstream inlets, other control devices or inundation of downstream areas.
- Easily damaged by vehicles and construction equipment.
- If the inlets become fully blocked, they can lead to downstream flooding. Ensure flooding does not occur.
- Hay bales are not considered appropriate as storm water inlet protection.

9.8.4 Key design and construction criteria

Design and construction specifications will vary according to the type of inlet protection, however, consider the following general principles:

- Maximum catchment area of 0.25 hectares to each inlet; stormwater inlet treatments should be limited to areas with a general slope of less than five percent, and the area immediately around the inlet should be less than one percent.
- Ensure the stormwater system retains adequate capacity. Inlet protection should not divert water over cut or fill, down slopes, or away from the stormwater inlet.
- Potential overflow scour needs to be considered during high intensity events or if geotextile fabric clogs. Always ensure a stable emergency bypass is included on all devices. Plan for where the bypass system will divert water to.
- Stormwater inlet protection around inlets at low points should be set back to allow the drain to function normally during periods of heavy rain.
- Ensure the location or operation of the device will not cause a public safety issue.
- An earthen bund placed immediately downslope of the device may hold ponded water around the inlet and prevent it from bypassing the drain.
- Keep stockpiles and loose sediment away from all drains and stormwater inlets.

The following sections outline several methods for inlet protection including:

- Silt fence.
- Filter fabric and aggregate.
- Sandbag check dams.
- Proprietary (off-the-shelf) products.

9.8.4.1 Silt fence

A silt fence can be erected around the inlet (see section 9.2 for general silt fence design). This method is appropriate where cesspits have been connected to a stormwater system and are collecting runoff from disturbed soil surfaces.

Support Silt fences well to avoid collapse and kept to less than 300mm in height so that runoff does not cause local flooding and/or is not directed into adjacent catchments.

9.8.4.2 Filter fabric and aggregate

All points where runoff can enter the cesspit should be protected with suitable geotextile fabric. Back entry sumps require additional fabric protection secured in place.

Lay coarse geotextile fabric over the cesspit and up onto the kerb with a layer of aggregate material to act as a primary filter and to hold the fabric in place.



Figure 9-25 Inlet protection with aggregate on top of geotextile fabric

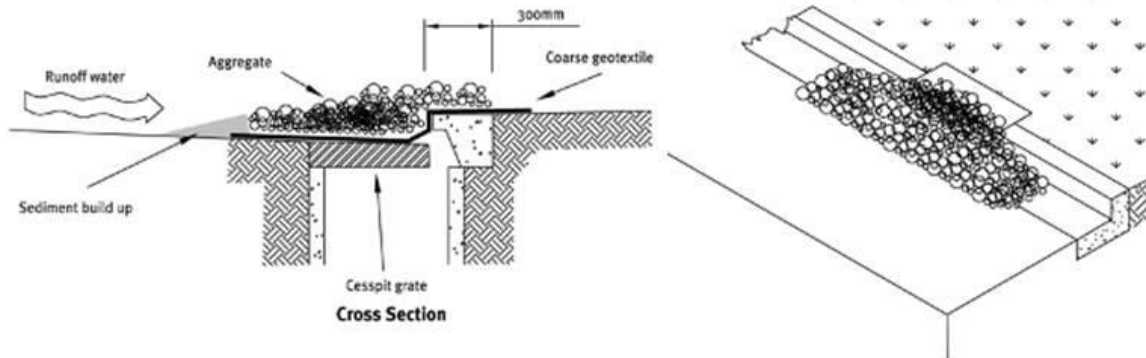

Figure 9-26 Stormwater Inlet Protection Filter Media Design

9.8.4.3 Sandbag Check dams

Place a series of low sandbag check dams up the gutter from cesspits to act as a series of sediment traps. The check dams require a spillway lower than the kerb to ensure that runoff does not encroach onto the berm area and cause scouring or flooding of adjacent properties.

Construct check dams out of up to six sandbags laid end to end, with no gaps, in an arc away from the kerb and up the road to create a series of impoundment areas.

Sediment that settles out behind the check dam on the road surface should be removed and disposed of to an appropriate location where it will not enter water.



Figure 9-27 Sandbag check dam in gutter

9.8.4.4 Proprietary (off-the-shelf) products

A number of 'off-the-shelf' products are available in New Zealand for example filter socks and catchpit inserts. The manufacturers' specifications should be followed in using these products.

These products can be used where road or parking surfaces are established, and some form of storm water inlet protection is required. They typically allow for high flow bypass and can also be relatively easily lifted from the storm water inlet and cleaned as required before reinstalling.

Additional support should be provided for filter socks and bags, so they are not pushed into the inlet by the force of the water.

9.8.5 Maintenance

Maintenance will vary according to the type of inlet protection however consider the following when maintaining stormwater inlet protection measures:

- Inspect daily and during and after rainfall events.
- Beware of blockages and leaks which may affect performance.
- Check to see if flows have been diverted away from the device and what if any damage has been caused.
- Clean all accumulated sediments immediately.

- Repair and modify any problems immediately.

9.8.6 Decommissioning

Decommissioning will vary according to the type of inlet protection however consider the following when decommissioning stormwater inlet protection measures:

- Ensure all areas within the contributing catchment are suitably stabilised before removal of inlet protection.
- Remove and dispose of accumulated sediments to an appropriate location.
- Remove the inlet protection, reuse and recycle components wherever possible.
- Stabilise any disturbed areas around the stormwater inlet.